

PRODUCT CODE	SIZE	FINISH	
LG.LA337	425	01.153	
PRODUCT		Satin Stainless Steel Grade 304	
PULL HANDLE	25mm diameter X 425mm centres		LAIDLAW GULF LLC

DESCRIPTION

PULL HANDLE

Features

- "T" Corner, Round Bar pull handle
- 25mm diameter
- 425mm centres
- 545mm total length
- 70mm projection
- Meet the requirements of BS8300 for DDA applications
- Supplied complete with back to back fixings to suit timber or steel door
- Stainless Steel Grade 304, Satin finish

IMAGE / TECHNICAL DRAWING

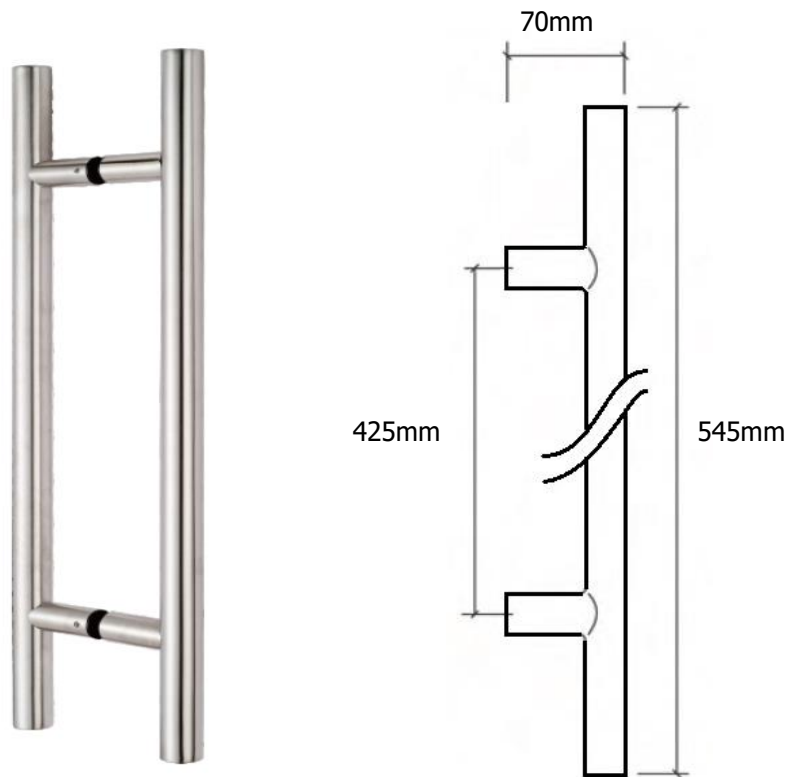

LAIDLAW GULF LLC
P.O. Box: 185292, 301 Mayfair Building, DIP-1, Dubai, UAE
Tel: 04-8857404 E-mail: info@laidlaw.ae
Website: www.laidlaw.ae

Member : Guild of Architectural Ironmongers



ISO 9001 Certificate number AE87236A

