

PRODUCT CODE	SIZE	FINISH	
LG.LA334	600	01.153	
PRODUCT		Satin Stainless Steel Grade 304	
PULL HANDLE	19mm diameter X 600mm centres		LAIDLAW GULF LLC

DESCRIPTION

PULL HANDLE

Features

- "T" Corner, Round Bar pull handle
- 19mm diameter
- 600mm centres
- 700mm total length
- 64mm projection
- Meet the requirements of BS8300 for DDA applications
- Supplied complete with back to back fixings to suit timber or steel door
- Stainless Steel Grade 304, Satin finish

IMAGE / TECHNICAL DRAWING

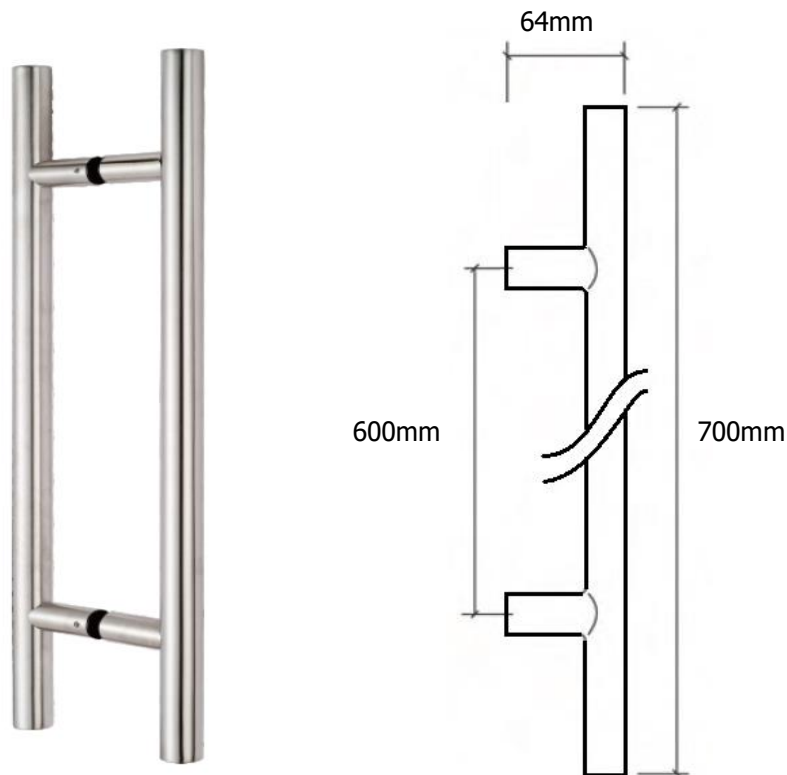

LAIDLAW GULF LLC
 P.O. Box: 185292, 301 Mayfair Building, DIP-1, Dubai, UAE
 Tel: 04-8857404 E-mail: info@laidlaw.ae
 Website: www.laidlaw.ae

Member : Guild of Architectural Ironmongers



ISO 9001 Certificate number AE87236A

