

HONESTY

RELIABILITY

INTEGRITY





PROUD SUPPLIERS OF



HONESTY

RELIABILITY

INTEGRITY

PERFECT FOR...

COMMERCIAL

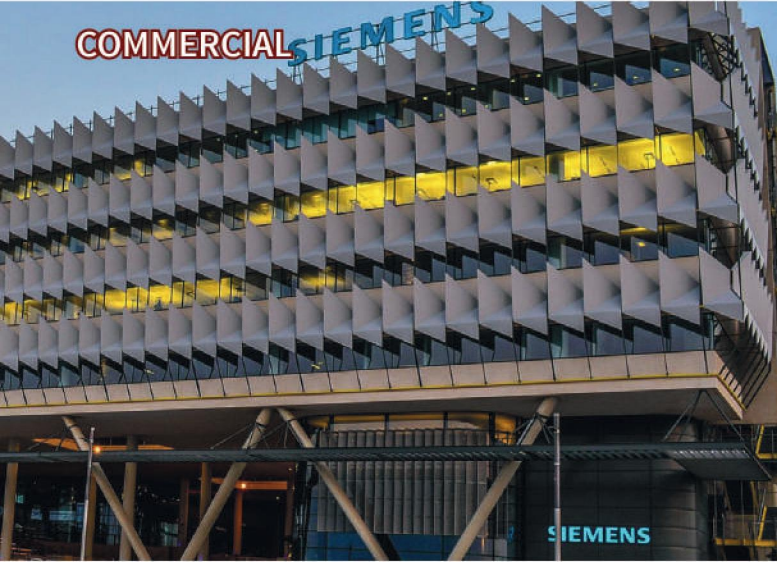

GOVERNMENT



HOSPITALITY



RESIDENTIAL

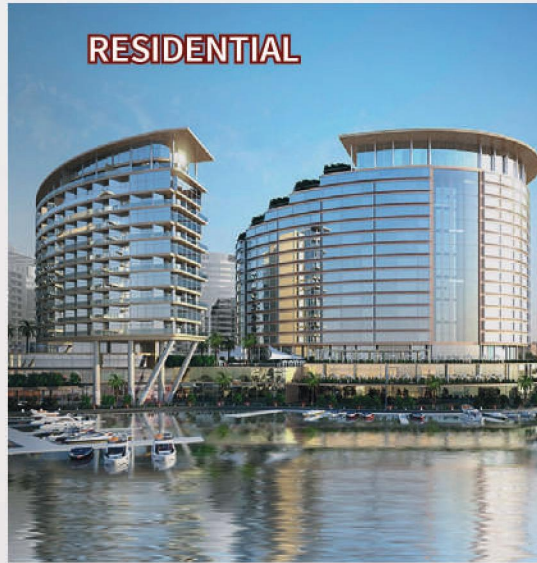

HEALTHCARE



EDUCATIONAL



RECREATION



INDEX

CERTIFICATION

INTRODUCTION

SERVICES

PROJECTS

- ▶ Hotels
- ▶ Government
- ▶ Education
- ▶ Commercial
- ▶ Healthcare
- ▶ Hospitality
- ▶ Recreation
- ▶ Residential

LGAI CONTRACT RANGE

PRODUCTS

- ▶ Hanging
- ▶ Closing
- ▶ Locking
- ▶ Operating
- ▶ Protecting
- ▶ Labelling
- ▶ Extras
- ▶ Furniture Fittings

LGAI for FM

LGAI for ID

LGAI for ARCHITECTS

LGAI for PROCUREMENT

CONTACTS

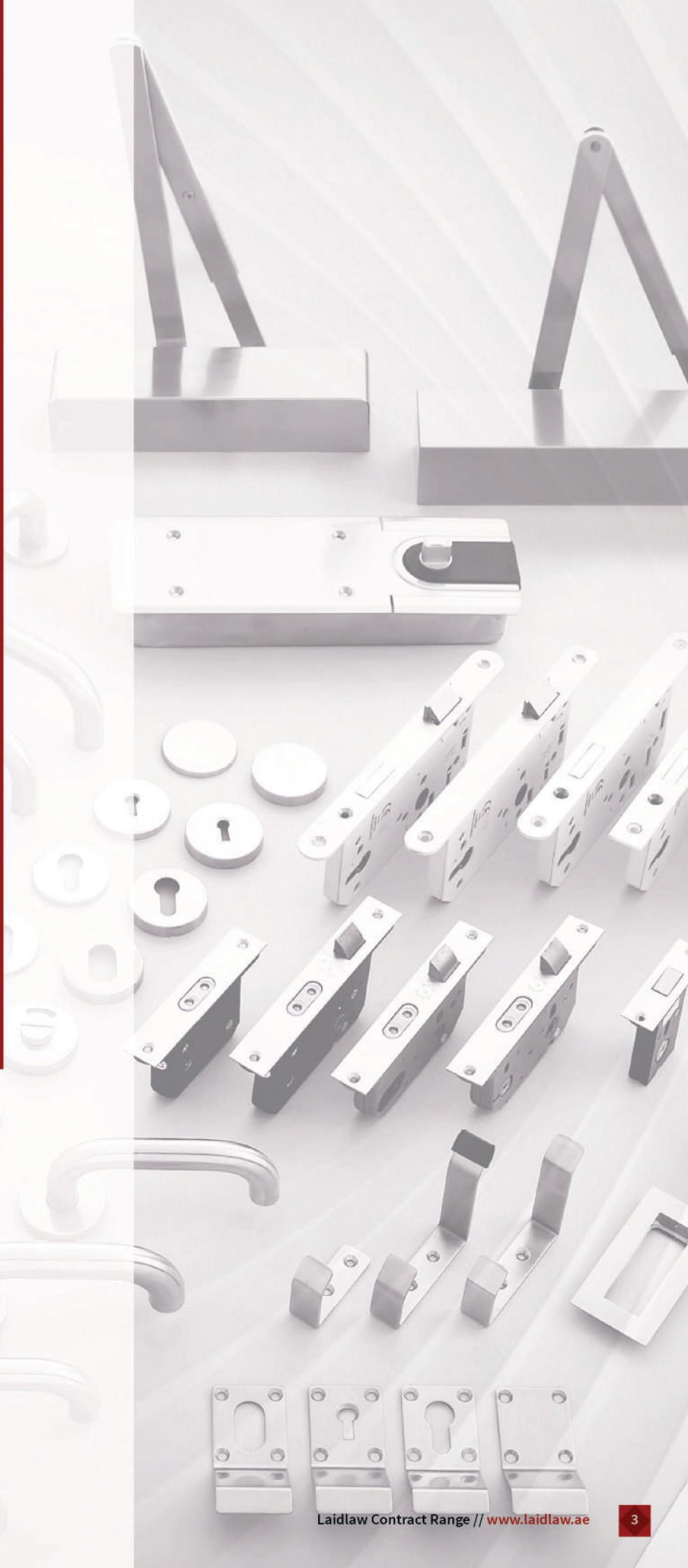



certificate of membership

this is to certify

Laidlaw Gulf LLC

**is a full member of the
Guild of Architectural Ironmongers**

A handwritten signature in black ink, appearing to read 'Julian Newman', is positioned above a horizontal dotted line.

president

guild of architectural ironmongers

A handwritten signature in black ink, appearing to read 'Julian Newman', is positioned above a horizontal dotted line.

vice president

guild of architectural ironmongers



CERTIFICATE

*This is to Certify that the
Quality Management Systems
of*

LAIDLAW GULF LLC

**Rm. 301 Mayfair Building, Dubai Investment Park 1,
Dubai, UAE.**

**has been independently assessed and is compliant
with the requirements of**

ISO 9001:2015

This Certificate is applicable to the following product or service ranges:

**Trading of Ironmongery, Wooden Products,
Reinforcement Steel Bars, Steel and
Basic Steel Products**

Certificate No.: AE87236A

Date of initial registration	03 December 2019
Date of this Certificate	03 December 2019
Surveillance audit on or before	02 December 2020
Recertification Due / Certificate expiry	02 December 2022

This Certificate is the property of LMS Certifications and remains valid
subject to satisfactory surveillance audits.

Director

For verification and updated information concerning the present certificate visit to www.lmscert.com

This Certificate is the property of LMS Certification Limited and shall be returned immediately when demanded.

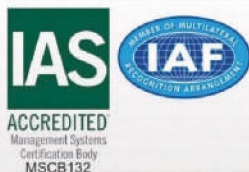

LMS Certification Limited
35 Park Hill, Huddersfield, HD2 1QG, West Yorkshire, United Kingdom.
Phone : +44 2089355094
Visit :- www.lmscert.com
E-mail :- info@lmscert.com



LMS/IAS/IF109Q/17/REV02



PROUD SUPPLIERS OF



Introduction

Laidlaw Gulf LLC is a market leader in the supply of architectural ironmongery and was established in the UAE in 2007. Since then, Laidlaw Gulf LLC has flourished in the MENA region, supplying numerous projects for our many customers.

Our business is to help architects, clients and contractors eliminate the problems associated with the specification and supply of project hardware by offering a turnkey solution. From scheduling to post installation consultancy, we will be with you every step of the way. We do not finish the project until you finish the project.

We are grateful for the support of our many customers, with whom we have worked closely to deliver several high-profile projects in the MENA region. We have built long standing relationships with our clients who include consultants, contractors, sub-contractors, door manufacturers and OEMs. We are proud to be part of their supply chains and we strive to provide excellent service together with high performance and cost-effective solutions to meet their requirements. The goodwill which Laidlaw Gulf LLC has created over many years continues today.

Our website details our product offering and brands, specifically our LGAI ironmongery range. We have also recently launched our furniture fittings range as a direct response to demand from our many customers in the joinery sector. This new range will become a key part of your design aesthetic. All our products are fully accredited and comply with global quality standards.

In these trying times that have seen many companies struggle, Laidlaw Gulf LLC has been growing from strength to strength. We welcome serving our customers in the MENA region and other international markets and we will continually strive to deliver excellent customer service in the years to come.

John Jefferies, CEO, Laidlaw Gulf LLC





Our Services

A COMPLETE RANGE OF PRODUCTS – We have created a product offering to suit clients design and financial requirements. Laidlaw Gulf offers a comprehensive range of door hardware and related products to provide the complete solution to every project. Our range supports all certification requirements by country (including EN and ANSI standard) and follows strict testing demands. We ensure that all door hardware required for fire escape and fire resisting doors is CE stamped guaranteeing suitability and quality. We can also offer everything from leading European brands to VE options if required. The only thing we never VE is our level of service.

A SCHEDULING SERVICE – We will schedule all your door hardware requirements from floor plans or from a door schedule, using a wide range of exclusive Laidlaw Gulf products. All schedules are tailored to meet legislative, aesthetic and financial requirements. Our team are trained to UK's Guild of Architectural Ironmongers Diploma holder status. Let them help you out today.

DOOR BAGGING – We know how busy you are on site. Let our dedicated team save your valuable time by delivering LGAI hardware in easy to install packages, marked for each individual door.

A PRE-TENDER AND POST-INSTALLATION CONSULTATION SERVICE – This includes advice on product type, use, cost, and site visits to provide post-installation “trouble-shooting” support. We will also interface with door suppliers and access control providers to ensure compatibility of related products and eliminate design and installation problems at an early stage.

Unlike other suppliers, we don't finish a project until you finish a project.

Product literature is available on demand.

For further details please contact our sales team: info@laidlaw.ae





Our Projects

Since 2007 LGAI has been the preferred product on a multitude of projects across the MENA region. When combined with our market leading levels of service, its not hard to see why Laidlaw Gulf has been the key supplier across a variety of market segments.

Perfect for: Commercial

- DWTC
- ICD Brookfield Place
- Aldar HQ
- Masdar HQ
- Al Naeem Mall

Perfect for: Education

- Zayed University
- NYU
- Paris Sorbonne
- GEMS School
- Formarke School
- RGS Guildford
- Hartland International School

Perfect for: Residential

- JLT One
- The City of Lights Tower
- Dubai Hills
- Barsha Residences
- Beach Vista
- Mulberry Heights
- Bloom Heights

Perfect for: Government

- Over 25 DEWA and EWA substations
- Farwania Court Complex
- Kuwait International Airport
- Sheikh al Jaber Causeway
- Almadi Police HQ

Perfect for: Healthcare

- Al Jalila Childrens Hospital
- Aster Hospital, Muscat
- Chest Diseases Hospital in Bahrain

Perfect for: Hospitality

- Aloft Hotels, Al Muneera, Nikki Beach,
- Centro Hotels, Four Seasons Hotels,

Eastern Mangroves, Jewel of The Creek and The Dorchester. Motiongate, Riverpark, Legoland, Meydan Racecourse

Whilst further afield LGAI products are on Al Ain Stadium and Qatar National Museum.

We are specified on the fastest growing cinema chain in the region, completing over 30 projects so far. We are also specified on numerous substations across the GCC, and have completed work across many Data Centres and Expo 2020 Pavilions. There is no industry and no project that is too big or small for Laidlaw Gulf. Simply put, we are Perfect for all.



Proud Suppliers of



HONESTY

RELIABILITY

INTEGRITY

PERFECT FOR...





Proud Suppliers of



HONESTY

RELIABILITY

INTEGRITY

PERFECT FOR...





Proud Suppliers of



HONESTY

RELIABILITY

INTEGRITY

PERFECT FOR...

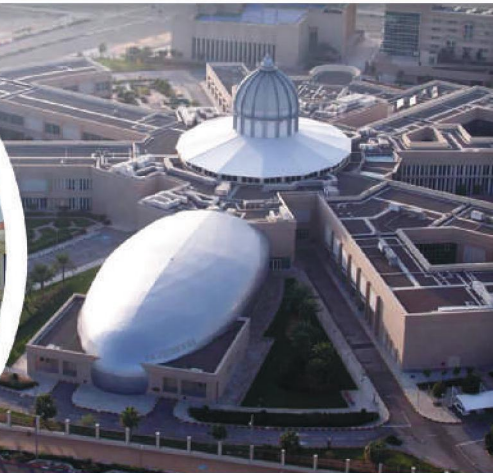

HONESTY

RELIABILITY

INTEGRITY

PERFECT FOR...

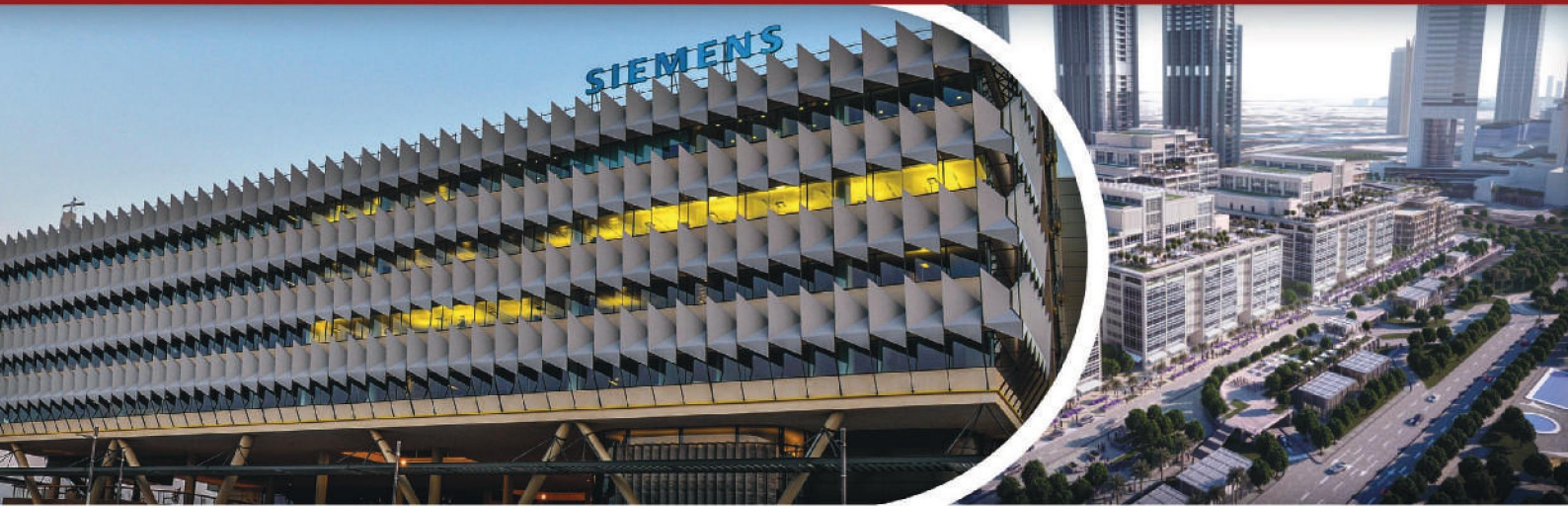



Proud Suppliers of



HONESTY

RELIABILITY

INTEGRITY

PERFECT FOR...





Proud Suppliers of



HONESTY

RELIABILITY

INTEGRITY

PERFECT FOR...





Proud Suppliers of



HONESTY

RELIABILITY

INTEGRITY

PERFECT FOR...





Proud Suppliers of



HONESTY

RELIABILITY

INTEGRITY

PERFECT FOR...



CONTRACT RANGE

The products listed within this publication are subject to a 10 year guarantee (unless otherwise stated) against defects proved to be the result of faulty manufacture or defective materials. Extended guarantees can be obtained for specific projects on application via your Laidlaw Gulf Technical Consultant and subject to an agreed maintenance programme.

Availability

The contract range is a selection of products developed by Laidlaw Gulf to meet the growing need for excellent performance at a competitive price. We hold much of our product range in our warehouse in DIP, ensuring our customers have quick and easy access to the products they need. If something isn't available, our supply chain team can get it to you ASAP.

Ordering

Please remember to specify the finish code after the product code as shown on next page, for example LG.LA02.140.01.153 for SS finish. If you have any questions, our sales team are happy to assist.

Materials and Finishes

Most products are available in Satin and Polished Stainless Steel. Our standard grade of stainless steel is 304, however we can also supply in 201 or 316 grades upon request. If you have had problems in the past securing the required grade, we are happy to show test results.

Certification

Our product range is fully certified to the necessary standards. We have a full range of EN and ANSI standard products. These products are available in FR or NFR as required. All of our products have been fully tested and are approved by DCD.

Supply Chain

Our product range is manufactured all over the world; UK, Germany, Italy, Spain, India, Canada and the Far East. As a UK company we always maintain the highest levels of service and production. Our excellent reputation is paramount to all our staff. As such, only the best products will be sourced for your projects.

Delivery

Our warehouse and delivery staff are available 24/7 to help with your urgent requirements. Our HSEQ policies require calling ahead before visiting our warehouse for collections. If you have a delivery scheduled, it WILL be on time. Our service levels are the highest in the industry.

MATERIAL GRADES	
CODE	GRADE
151	201
152	202
153	304
154	316
155	21CT
150	OTHER BASE MATERIALS

LIDLAW GULF PRODUCT CODE EXPLANATION

LG.LA60.5572.01.153

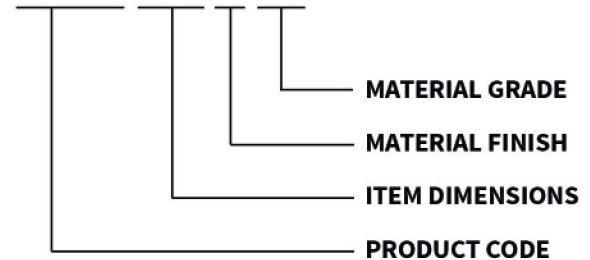

PRODUCT CODES & FINISHES

CODE	FINISH		DESCRIPTION
01	SSP		SATIN STAINLESS STEEL
02	PSS		POLISHED STAINLESS STEEL
03	SCP		SATIN CHROME PLATED
04	SNP		SATIN NICKEL PLATED
05	CP		CHROME PLATED
06	NP		NICKEL PLATED
07	GALV		GALVANIZED
08	BLACK		BLACK ELECTROPLATED / POWDER COATED
09	COLOUR		COLOURED NYLON MATERIAL
10	PL		PLASTIC
11	AB		ANTIQUE BRASS
12	SAA		SATIN ANODIZED ALUMINIUM
13	PAA		POLISHED ANODIZED ALUMINIUM
14	ALUM		MILL ALUMINIUM
15	SSS/PSS		DUO FINISH SATIN & POLISHED STAINLESS STEEL
16	SILVER		SILVER
17	GOLD		GOLD FINISH
18	SB		SATIN BRASS
19	PB		POLISHED BRASS
20	SBP		SATIN BRASS PVD
21	ABR		ANTIQUE BRONZE
22	SBR		SATIN BRONZE
23	PBR		POLISHED BRONZE

HONESTY

RELIABILITY

INTEGRITY

PERFECT FOR...

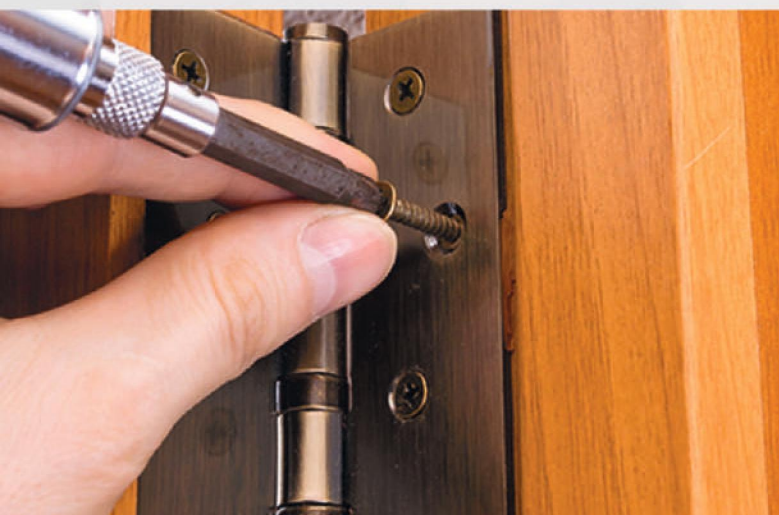

HANGING THE DOOR

HINGES

BALL BEARING HINGES

RADIUS CORNERED HINGES

All sizes available by order



Square Cornered Hinges

LG Code	Size HXW
LG.LA150.076	76 X 50 X 2MM
LG.LA150W.076	76 X 50 X 2MM
LG.LA160W.102	102 X 76 X 2MM
LG.LA160C.102	102 X 76 X 3MM
LG.LA160.102B	102 X 76 X 2.5MM
LG.LA160S.102	102 X 76 X 3MM
LG.LA160H.102	102 X 76 X 3MM
LG.LA160.102	102 X 76 X 3MM
LG.LA166.102	102 X 89 X 3MM
LG.LA161.102	102 X 102 X 3MM
LG.LA167.114	114 X 102 X 3MM
LG.LA167.114B	114 X 114 X 3MM
LG.LA168.114	114 X 102 X 3MM
LG.LA168.114B	114 X 114 X 3.5MM
LG.LA178.127	127 X 76 X 3MM
LG.LA178.089	127 X 89 X 3MM
LG.LA178.102	127 X 102 X 3MM

Radius Cornered Hinges

LG Code	Size HXW
LG.LA150.076R	76 X 50 X 2MM
LG.LA150W.076R	76 X 50 X 2MM
LG.LA160W.102R	102 X 76 X 2MM
LG.LA160C.102R	102 X 76 X 3MM
LG.LA160.102BR	102 X 76 X 2.5MM
LG.LA160S.102R	102 X 76 X 3MM
LG.LA160H.102R	102 X 76 X 3MM
LG.LA160.102R	102 X 76 X 3MM
LG.LA166.102R	102 X 89 X 3MM
LG.LA161.102R	102 X 102 X 3MM
LG.LA167.114R	114 X 102 X 3MM
LG.LA167.114BR	114 X 114 X 3MM
LG.LA168.114R	114 X 102 X 3MM
LG.LA168.114BR	114 X 114 X 3.5MM
LG.LA178.127R	127 X 76 X 3MM
LG.LA178.089R	127 X 89 X 3MM
LG.LA178.102R	127 X 102 X 3MM

- ▶ Ball bearing hinge
- ▶ Exceed BSEN 1935 grade 13 suitable for doors up to 120kg (Weight based on 3 hinges per door leaf)
- ▶ Fire tested to EN 1634-1
- ▶ Radiused and square corner versions
- ▶ Stainless steel versions are Grade 304
- ▶ Supplied with 32mm X No.10 pozidrive stainless steel wood screws
- ▶ Security stud option
- ▶ Hinge variations to order
- ▶ Hospital TIP - Add suffix 'H'
- ▶ Non Removable PIN - Add suffix 'NRP'
- ▶ Final I Ball TIP Hinges - Add suffix 'FT' or 'BT'
- ▶ Metal Screws - Add suffix 'M'
- ▶ Wooden Screws - Add suffix 'W'

NON-FIRE DOOR APPLICATIONS



- ▶ Rising butt hinges suitable for light internal doors, providing a soft 'self closing' action
- ▶ Must be specified as Clockwise Closing (CW) or Anti-Clockwise Closing (ACW)
- ▶ Stainless steel versions are Grade 304
- ▶ Supplied with 32mm x No.10 pozidrive zinc plated wood screws
- ▶ Maximum adjusted door weight 60kg
- ▶ 2 hinges per leaf recommended
- ▶ Require regular maintenance

Rising butt hinges

Item no.	Handing	Finishes		Unit
		SS		
LG.LA 176L.102.01.153	LH	•		single
LG.LA 176R.102.01.153	RH	•		single

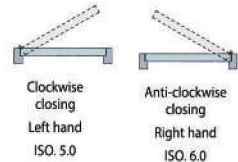

Lift Off hinge

Item no.	size(mm)	Finishes			Unit
		SS	Ps		
LG.LA.177L.102.01.153	LH 102 x 76 x 3mm	•	•		single
LG.LA.177R.102.01.153	RH 102 x 76 x 3mm	•	•		single
LG.LA.177L.102R.01.153	LH 102 x 76 x 3mm	•	•		single
LG.LA.177R.102R.01.153	RH 102 x 76 x 3mm	•	•		single

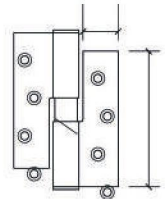

*Available to order - Lift Off Hinge sizes : 102 x 89 x 3mm, 102 x 102 x 3mm

FIRE DOOR APPLICATIONS

- ▶ When used on fire doors, intumescent packs need to be specified ITH - Specify hinge size upon ordering
- ▶ For 30 min. fire door applications specify 1 mm material
- ▶ For FD60 & FD90 specify 2mm intumescent packs

CONCEALED HINGES

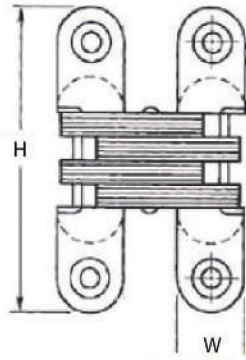

LG.LA192

- ▶ Concealed hinge with 2D adjustment
- ▶ Size : 45mm X 13mm
- ▶ Suitable up to 10kg door weight (2 hinges)
- ▶ Suitable for non fire rated doors
- ▶ Satin Nickel Plated finish

Concealed Hinges 2D Adjustment

LG Code	Size HXW	Weight Capacity
LG.LA192.4513.04.150	45 X 13MM	2 HINGES - 10 KG
LG.LA192.6013.04.150	60 X 13MM	2 HINGES - 15 KG
LG.LA192.7016.04.150	70 X 16MM	2 HINGES - 20 KG
LG.LA192.9519.04.150	95 X 19MM	2 HINGES - 30 KG
LG.LA192.11825.04.150	118 X 25MM	2 HINGES - 40 KG
LG.LA192.11828.04.150	118 X 28MM	2 HINGES - 50 KG
LG.LA192.13834.04.150	138.5 X 34MM	2 HINGES - 60 KG
LG.LA192.9519.01.153	95 X 19MM	2 HINGES - 30 KG
LG.LA192.11825.01.153	118 X 25MM	2 HINGES - 40 KG
LG.LA192.11828.01.153	118 X 28MM	2 HINGES - 50 KG
LG.LA192.13834.01.153	138.5 X 34MM	2 HINGES - 60 KG

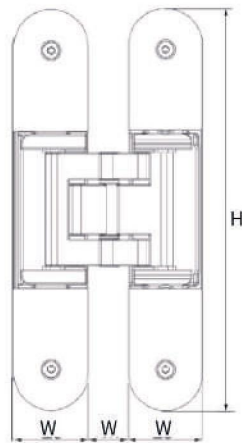

LG.LA193

- ▶ Concealed hinge with 3D adjustment
- ▶ Size : 110mm X 24mm X 29/25mm
- ▶ Suitable up to 40kg door weight (2 hinges)
- ▶ Suitable for non fire rated doors
- ▶ Satin Nickel Plated finish

Concealed Hinges 3D Adjustment

LG Code	Size HXW	Weight Capacity
LG.LA193.1124.04.150	110 X 24 X 29/25MM	2 HINGES - 40 KG
LG.LA193.1130.04.150	140 X 30 X 25/25MM	2 HINGES - 60 KG
LG.LA193.1628.04.150	160 X 28 X 31/34MM	2 HINGES - 80 KG
LG.LA193.2032.04.150	200 X 32 X 36/36MM	2 HINGES - 120 KG
LG.LA193.2432A.04.150	240 X 32 X 42/44MM	2 HINGES - 160 KG
LG.LA193.2432B.04.150	240 X 32 X 36/36MM	2 HINGES - 200 KG
LG.LA193.1628.01.153	160 X 28 X 33/33MM	2 HINGES - 120 KG
LG.LA193.1946.01.153	190 X 46 X 47/47MM	2 HINGES - 200 KG
LG.LA193.2350.01.153	230 X 50 X 49/49MM	2 HINGES - 300 KG
LG.LA193.1025.04.150	100 X 25 X 20/20MM	2 HINGES - 40 KG

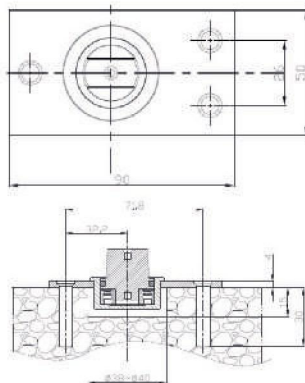
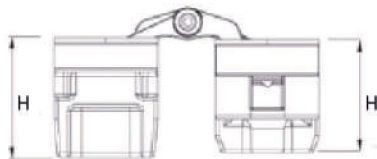

LG.LA902

HEAVY DUTY PIVOT

- ▶ Floor mounted
- ▶ Size: 90mm X 50mm X 4mm
- ▶ Suitable up to 250kg door weight
- ▶ Stainless Steel Grade 304, Satin finish
- ▶ Supplied with Tox and screws for concrete fixing

HONESTY

RELIABILITY

INTEGRITY

PERFECT FOR...



FLOOR SPRING

FLOOR SPRINGS

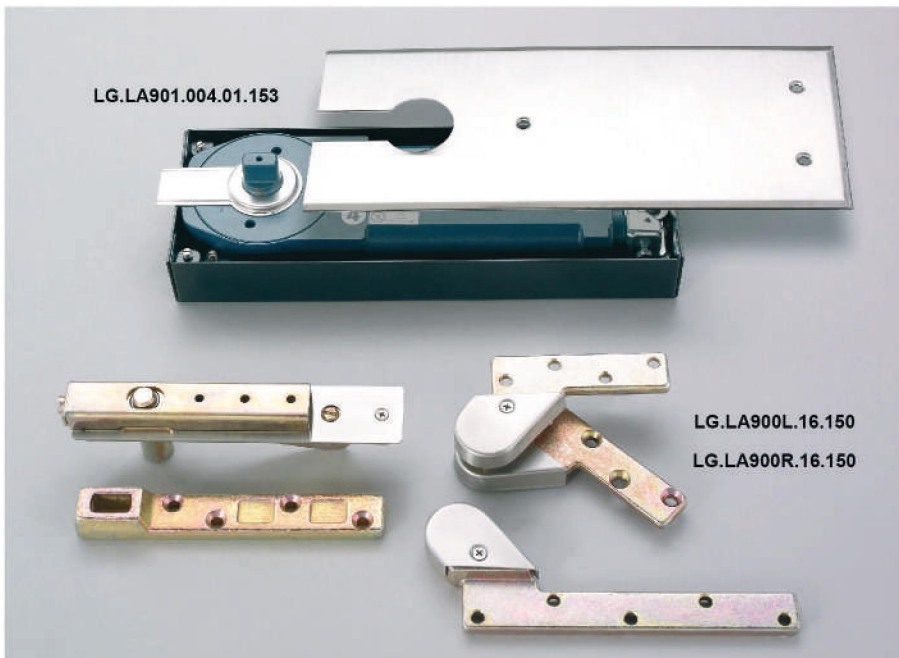

Suitable for heavy duty applications on single or double action doors up to 150kg. Features include:

- ▶ CE marked suitable for fire door applications
- ▶ Fixed strength size 4 (Size 5 to order)
- ▶ Adjustable closing speed
- ▶ Angle of opening 130°.
- ▶ Hold-open available to order (90° & 105°) For non fire rated doors
- ▶ Adjustable backcheck available to order
- ▶ Large range of adjustment for door alignment
- ▶ Supplied complete with top centre, bottom strap and satin stainless steel cover plate
- ▶ Single action and double action variants
- ▶ Fire tested to EN 1634 for 1 hour on timber doors and 4 hours on steel doors
- ▶ UL Listed

Item no.	Description	single action	double action
LG.LA901.004.01.153	Floor spring - size 4	•	•
LG.LA900L.16.150	Single action accessories- LH	•	-
LG.LA900R.16.150	Single action accessories- RH	•	-

BS EN Classifications

The following floor springs have been designated with the Classification number as shown side.

LG.LA901.004.01.153 3 8 4 1 1 3

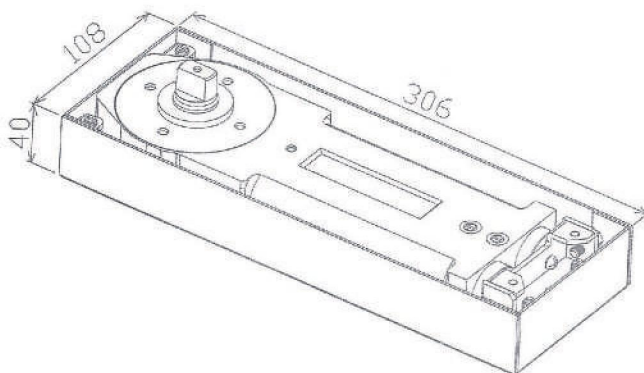

Power sizes

Contract Range floor springs are fixed power size 4 for doors up to 150kg and 1100mm wide.

Size 5 power size for doors 1250 mm wide x 200 kg available to order

Note : Floor springs are supplied Non - Hold Open (NHO) and Hold Open (HO)

For doors outside these parameters please contact your Laidlaw Gulf Technical Consultant.

10 Year Gurantee

- ▶ Refer page No. 17 & 18 for Codes, Grades & Finishes

SURFACE MOUNTED DOOR CLOSERS

OVERHEAD DOOR CLOSERS

A series of CE marked surface mounted overhead door closers with either a slide in cover plate or with an all-over cover concealing all fixings and adjustment screws.



This series of closers is designed to provide a wide range of the most popular functional features with optional cover and armset variations. The main features of this series include full certification to EN1154, EN1634 and CE Marking.

See product selector table below for full range of features

BS EN Classifications

The following closers have been designated with the classification number as shown below.

LG.LA801.204.16.150 4 8 2-4 1 1 3

LG.LA802.205.16.150 4 8 2-5 1 1 3

LG.LA806.306.16.150 4 8 3-6 1 1 3

The range provides the following features:

- ▶ Fully certified to EN1154, EN1634 and CE Marked
- ▶ Adjustable power up to EN size 6
- ▶ Adjustable for closing speed, latch action, backcheck and with optional delayed action (see table below)
- ▶ Reversible for LH & RH applications
- ▶ Flat form or screw type arms
- ▶ Suitable for fig.1, fig.61 & fig.66 mounting
- ▶ Hold open armset packs available for some modes (not suitable for fire doors)

Features & Functions	Item no.	LG.LA801.204.16.150	LG.LA802.205.16.150	LG.LA806.306.16.150
Power size (see chart opposite)		2-4	2-5	3-6
Fixed power or adjustable		adjustable	adjustable	adjustable
Template or spring power adjustable		template	spring	spring
BS EN 1154 compliant		•	•	•
CE Marked		•	•	•
Grade of opening angle (see note #)		4	4	4
Adjustable closing speed		•	•	•
Adjustable latch action		•	•	•
Adjustable back check		to order	•	to order
Adjustable delayed action		to order	to order	to order
Hold open armset option - to order		•	•	•
Fire tested to EN 1634-2 hour (timber door)		•	•	•
Fire tested to EN 1634-4 hour (steel door)		•	•	-

Finishes

All closers are supplied with armsets and brackets to match the body finish.

02 - Polished Stainless Steel

01 - Satin Stainless Steel

16 - Silver Sprayed

Closers with all over cover and flat armset

Item ref	Dimensions (mm)		
	L	H	D
LG.LA801 ...	270	70	40
LG.LA802 ...	270	70	40
LG.LA806 ...	307	77	47

Trim plate closers with screw type armset

Item ref	Dimensions (mm)		
	L	H	D
LG.LA801 ...	204	55	39
LG.LA802 ...	236	55	39
LG.LA806 ...	275	62	45

▶ Accessories

A range of accessories is available for use with all Contract Range surface mounted door closers.

10 Year Guarantee

SURFACE MOUNTED DOOR CLOSERS

OVERHEAD DOOR CLOSERS

An economical closer which has a full range of functions including adjustable power and backcheck capability.



This closer has the following features:

- ▶ Suitable for fire door applications
 - ▶ Fire tested to EN 1634 up to 60 minutes and UL Listed
 - ▶ Adjustable power size 2 - 4 suitable for doors up to 80kg and 1100mm wide (see chart below)
 - ▶ Adjustable closing speed and latch action
 - ▶ Simple installation and adjustment
 - ▶ Sprayed silver finish with other colours available
- (Please contact your Laidlaw Gulf Consultant for details)

Finishes

This closer is available in sprayed finishes with arms and brackets to match.

16 - Silver Sprayed

Features & Functions	Item No.	LG.LA803.204.16.150
Power size (see chart opposite)		2-4
Fixed power or adjustable		adjustable
Template** or spring power adjustable		template
BS EN 1154 compliant & CE Marked		-
Grade of opening angle (see note #)		4
Adjustable closing speed		•
Adjustable latch action		•
Adjustable back check		to order
Adjustable delayed action		-
Hold open armset option - to order		•
Fire tested to EN 1634-1 hour (timber door)		•
Fire tested to EN 1634-4 hour (steel door)		-

Grade 4 will close a door from 180° opening angle.

** By altering the mounting position of the closer, the closing strength can be adjusted

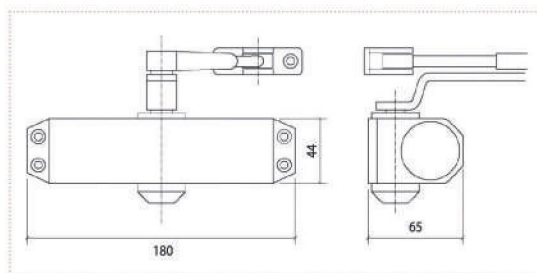

	Door width (mm)	750mm	850mm	950mm	1100mm	1250mm	1400mm
1	20kg						
2	40kg						
3	60kg						
4	80kg						
5	100kg						
6	120kg						

Power sizes

The dimensions stated in the chart above relate to closers mounted on the pull side of the door (fig.1 applications) only.

▶ Accessories

A range of accessories is available for use with all Contract Range surface mounted door closers.

10 Year Guarantee

SURFACE MOUNTED OVERHEAD DOOR CLOSER

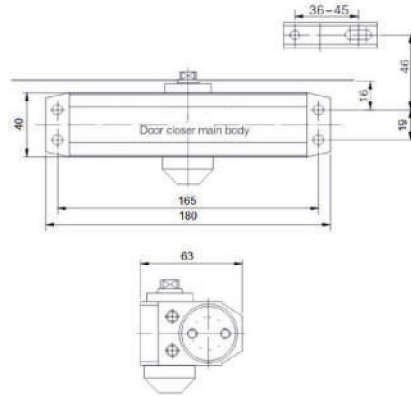

LG.LA8110

Features:

- ▶ Power size EN 3
- ▶ Suitable from 40 to 60kg door weight
- ▶ Suitable up to 950mm door width
- ▶ Adjustable closing and latch action
- ▶ Reversible for LH & RH applications
- ▶ Supplied with standard scissor arm
- ▶ Silver painted finish

Classification

- ▶ Tested to BS EN 1154
- ▶ CE Marked : Approved product
- ▶ Certifire Certificate number: CF5928 with classification codes: 4/8/3/1/1/3
- ▶ Fire safety: Suitable for fire rated doors

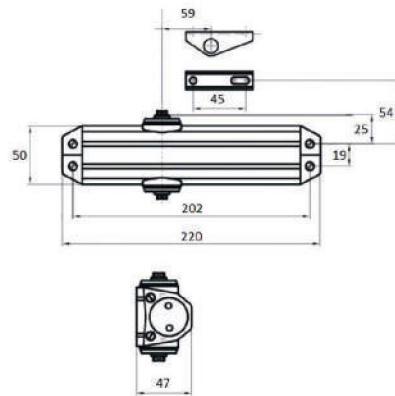

LG.LA8210

Features:

- ▶ Adjustable power size EN 2-4
- ▶ with adjustable back check as a standard feature.
- ▶ Adjustable closing and latch action
- ▶ Non Handed
- ▶ Suitable up to 1100mm door width
- ▶ Suitable up to 80kg door weight
- ▶ Body and Arm in Silver painted finish

Classification

- ▶ Tested to BS EN 1154
- ▶ CE Marked : Approved product
- ▶ Certifire Certificate number: CF5928 with classification codes: 3/8/2-4/1/1/3
- ▶ Fire safety: Suitable for fire rated doors

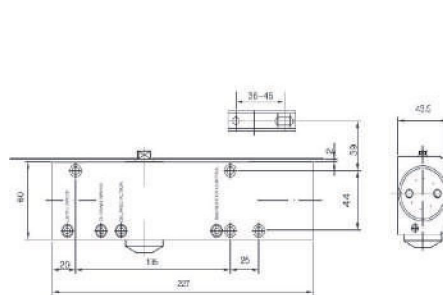

LG.LA8410

Features:

- ▶ Adjustable power size EN 2-5
- ▶ Adjustable closing and latch action
- ▶ Optional Back check and delayed action available
- ▶ Reversible for LH & RH applications
- ▶ Suitable up to 1200mm door width
- ▶ Suitable up to 100kg door weight
- ▶ Body and Arm in Silver painted finish

Classification

- ▶ Tested to BS EN 1154
- ▶ CE Marked : Approved product
- ▶ Certifire Certificate number: CF5928 with classification codes: 4/8/2-5/1/1/3
- ▶ Fire safety: Suitable for fire rated doors

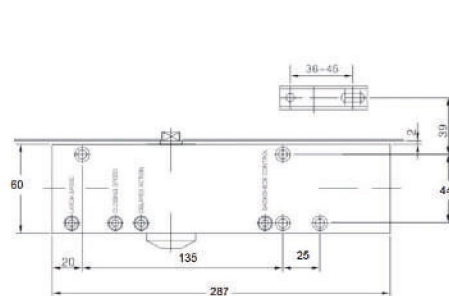

LG.LA8420

Features:

- ▶ Adjustable power size EN 3-6
- ▶ Adjustable closing and latch action
- ▶ Optional Back check and delayed action available
- ▶ Reversible for LH & RH applications
- ▶ Suitable up to 1400mm door width
- ▶ Suitable up to 120kg door weight
- ▶ Body and Arm in Silver painted finish

Classification

- ▶ Tested to BS EN 1154
- ▶ CE Marked : Approved product
- ▶ Certifire Certificate number: CF5928 with classification codes: 4/8/3-6/1/1/3
- ▶ Fire safety: Suitable for fire rated doors

SURFACE CLOSER ACCESSORIES









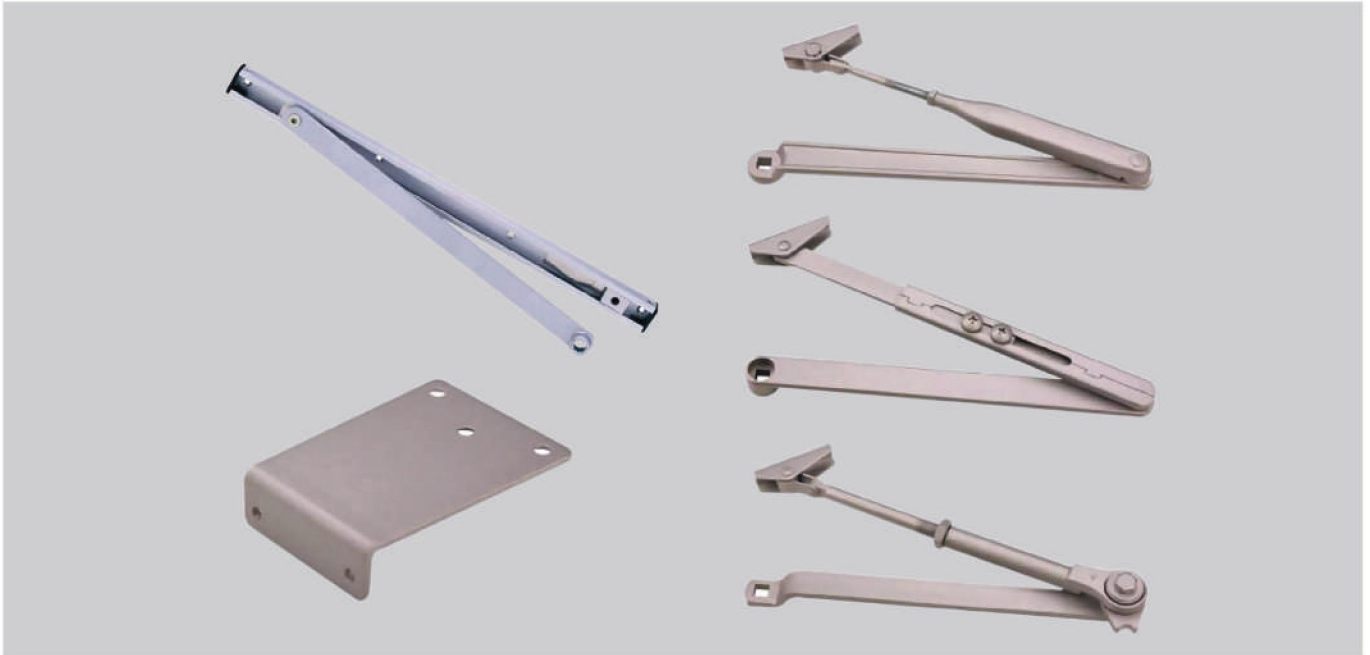

DOOR CLOSER ACCESSORIES

A series of accessories is available for use with the Contract Range of surface mounted door closers. Please refer to the table for applications to each door closer.

Supplied in finishes to match the door closer body

All accessories supplied with appropriate fixings for timber or steel doors



Accessories			LG.LA801.204.16.150	LG.LA802.205.16.150	LG.LA806.306.16.150	LG.LA803.204.16.150
	SA	standard arm	● ●	● ●	● ●	● ●
	FA	extended arm	● ●	● ●	● ●	● ●
	HOA	hold-open arm	● ●	● ●	● ●	● ●
	TA*	track arm	●	●	●	●
	PA*	parallel arm bracket	○	○	○	○
	FPI	glass door shoe	○	○		
	FP2	drop plate	○	○	○	
	FP3	angle bracket	○	○	○	
	FP4	mounting backplate	○	○	○	
	FPS	arm adapter plate	○	○	○	○

* Use of track arm or parallel arm bracket will reduce the power size of the closer by at least one power size.

- available with the closer body as a set
- available for sale separately to the closer body
- optional accessory

CONCEALED DOOR CLOSERS

CONCEALED DOOR CLOSERS

A series of concealed overhead door closers designed to be installed into the head of the door with a slide track installed into the underside of the transom. These concealed closers are ideally suited to applications where an exposed door closer is not desirable from aesthetic or functional grounds.

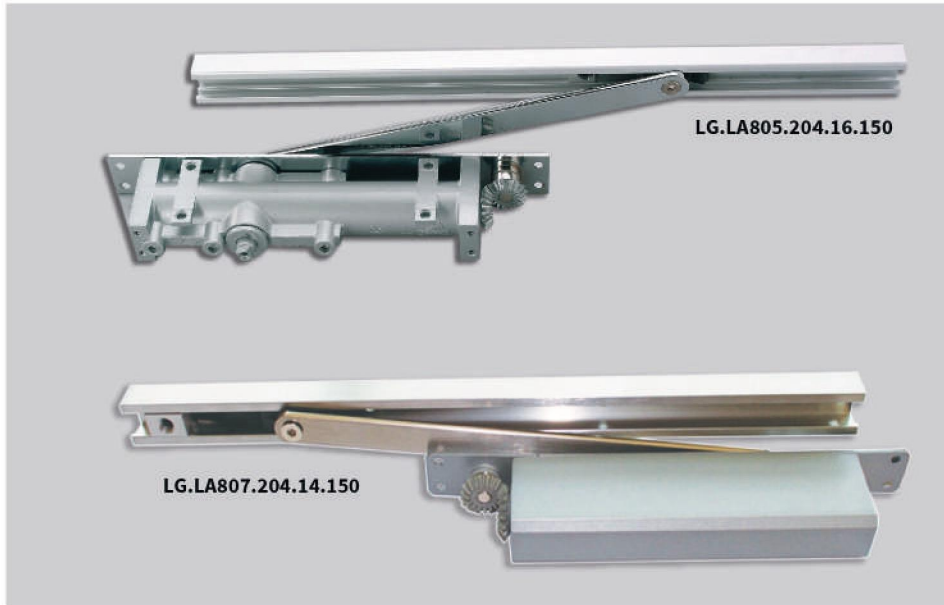

- ▶ Fire tested to EN 1634 up to 60 minutes and UL Listed
- ▶ Fixed and adjustable power variants
- ▶ Adjustable closing speed and latch action
- ▶ Controlled closing from 120°
- ▶ Reversible for LH and RH applications
- ▶ Hold-open track available (not suitable for use on fire doors)
- ▶ Intumescent pack available for use on fire doors
- ▶ Special finishes available on order

Features & Functions	Item no.	LG.LA804.003.16.150	LG.LA805.204.16.150	LG.LA807.204.04.150
Power size (see chart opposite)		3	2-4	2-4
Fixed power or adjustable		fixed	adjustable	adjustable
Power adjustment by position or spring		-	spring	spring
Angle of opening		120°	120°	120°
Adjustable closing speed		•	•	•
Adjustable latch action		•	•	•
Adjustable back check		-	optional	self regulation
Adjustable delayed action		-	-	-
Fire tested to EN 1634 on timber door- Size 3		1 hour	1 hour	1 hour
UL Listed		•	•	CE marked
*Hold-open track		•	•	•
Reversible for LH and RH applications		•	•	•
Minimum door thickness		44mm	50mm	44mm

* to be disengaged for fire door applications

All dimensions are shown in mm

10 Year Guarantee

▶ Refer page No. 17 & 18 for Codes, Grades & Finishes

CONCEALED DOOR CLOSERS

BS EN 1154 Power size	Door width (mm)	750mm	850mm	950mm	1100mm	1250mm	1400mm
	Door weight (kg)						
1	20kg						
2	40kg						
3	60kg						
4	80kg						
5	100kg						
6	120kg						

Laidlaw LA807 Applications and fixing details

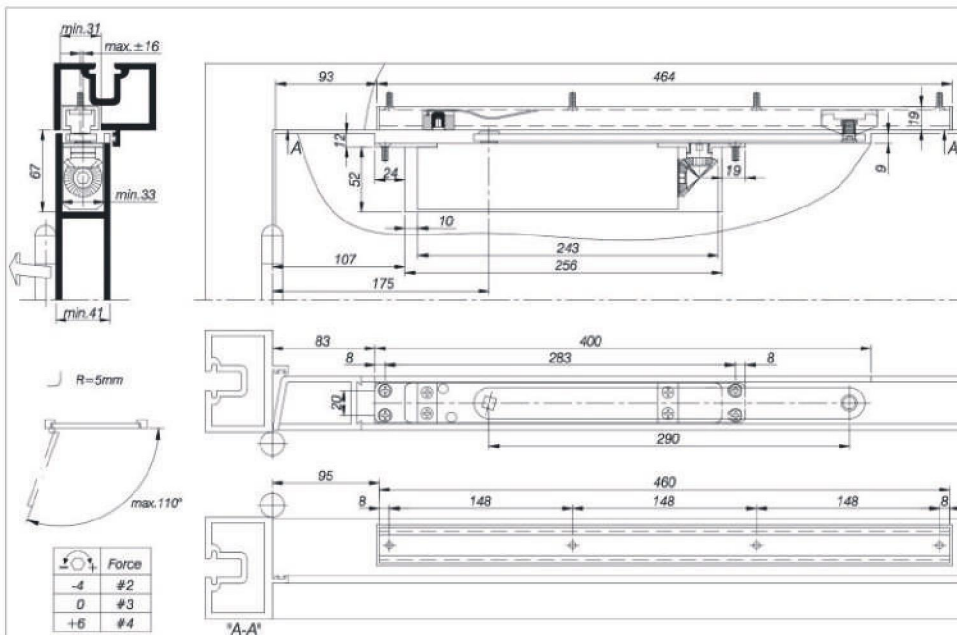

Depending on the structural conditions, the door opening angle with this method of fixing is limited to approx. 110° to 115° in order to avoid damage to the door or door closer, users are recommended to use a cushioned backstay or a door stop.

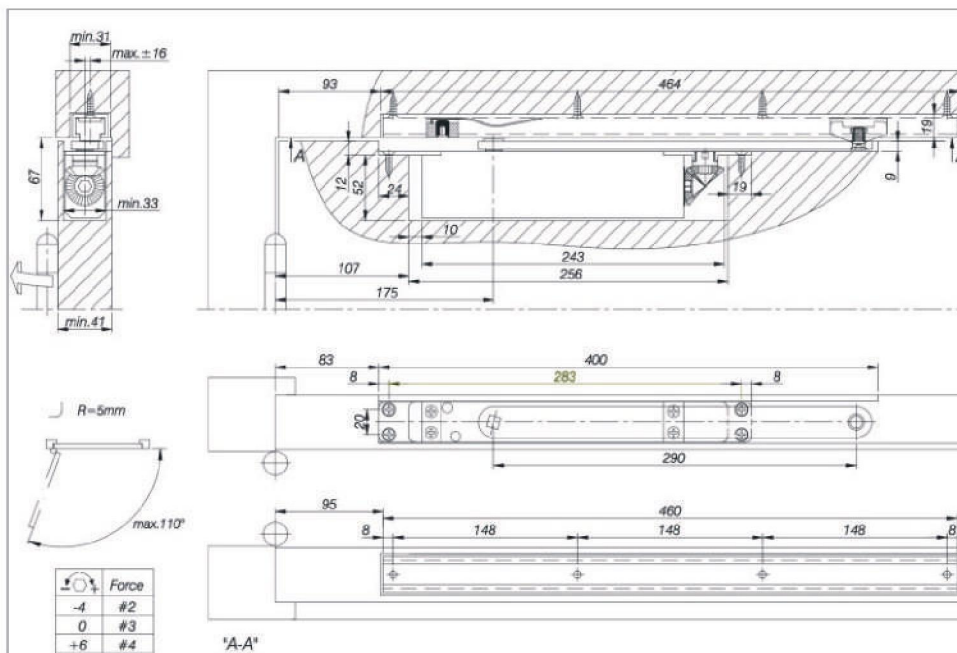

All dimensions are shown in mm

FIRE DOOR CONTROLS

ELECTROMAGNETIC DOOR HOLDERS

Wall and floor mounted electromagnetic door holders are used in conjunction with either an overhead door closer or floor spring. When connected to the building fire/smoke detection and alarm system they will allow a fire door in a high traffic location, such as a corridor, to be held open during normal use. In an emergency situation the holder is de-activated and the door closes under the action of the door closer. The door can always be pulled manually off hold open to allow the door to close.

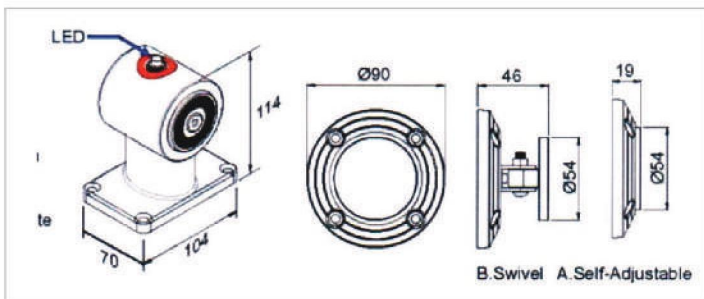
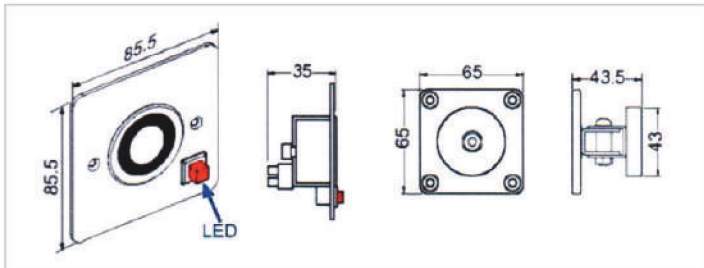

- ▶ Fully compliant with BSEN 1155
- ▶ CE Marked
- ▶ Surface or semi recessed wall mounting
- ▶ Built-in LED button to simulate alarm conditions
- ▶ Swivel armature plates
- ▶ Floor mounting bracket option
- ▶ Max. holding force LG.GD640S – 70 lbs
LG.GD850F – 80lbs
- ▶ 1 year electrical guarantee

Item no.	description	Finish
LG.GD640S	wall mounted -semi recessed	ss
LG.GD850F	floor mounted	black

Specification advice

The hold-open device should be sited at the same level as the closing device (or as close as practical) to minimise the stress placed on the door whilst it is being held open. A skirting mounted hold-open unit used in conjunction with an overhead door closer could induce the door to twist, causing the door to fail to close fully.

Power for the electromagnet must not be drawn from the fire alarm system except in alarm condition. A separate power supply is designed specifically for the electromagnetic units.

3 5 3 1 1 3

BS EN Classifications

Contract Range electromagnetic hold-open units have been fully tested to the requirements of BS EN 1155 and have been designated with the Classification no. as shown above.

Electrical requirements

Operating voltage- 24vDC (22v min | 30v max.)
60mA nominal (Note : 12VDC to order)

Note:

The door holder should not be positioned at such a point where the door can be held open at angles less than 65°

GD640S



GD850F



HONESTY

RELIABILITY

INTEGRITY

PERFECT FOR...



LOCKING THE DOOR

LOCKCASES & LATCHES

EURO PROFILE MORTICE LOCKCASES

An integrated series of modular euro profile cylinder mortice lockcases designed to meet the requirements of BS EN 12209

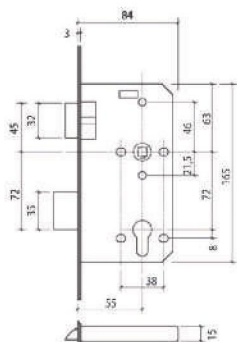

- ▶ Slim line case with 8 function variants
- ▶ Modular design allows interchangeability of lock models
- ▶ Meets the requirements of BS EN 12209 and with the dimensional characteristics of DIN18251
- ▶ 55 or 60mm backset (Escape sash lock 55mm backset)
- ▶ 72mm Euro profile centres
 - ▶ 78mm bathroom centres
- ▶ Bolt through hardware fixings
 - ▶ 20mm double throw dead bolt
- ▶ Quick reversible latch bolt
 - ▶ Springing suitable for unsprung lever furniture
- ▶ Single piece forend in grade 304 or 316 stainless steel with matching strike plate
- ▶ Square forends as standard. Radiused forends available to order
- ▶ Meets BS 8300 dimensional recommendations making it suitable for DDA applications
- ▶ Nightlatch function without hold-back facility

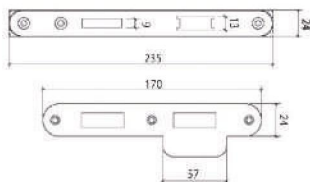

Item no.	Function	Finishes		Unit
		SS	PS	
LG.LA60.5572.01.153	Sashlock	•	–	single
LG.LA61.5500.01.153	Deadlock	•	–	single
LG.LA62.5500.01.153	Latch	•	–	single
LG.LA63.5578.01.153	Bathroom lock	•	–	single
LG.LA66.5500.01.153	Sliding door lock	•	–	single

Classification to EN 12209:2003
 Example:
 LG.LA60.5572.01.153
 3-X-8-1-0-G-3-B-C-2-0
 For other classification information contact sales office.

Fire Door Applications
 When used on fire doors, intumescent packs need to be specified
 • ITL -160 X 90 I FD30 1mm Lock Kit
 • ITL -160 X 90 I FD60 2mm Lock Kit
 • ITL -160 X 90 I FD90 2mm Lock Kit

Special Function Locks

Item no.	Function	Finishes		Unit
		SS	PS	
LG.LA64.5500.01.153	Nightlatch (without hold back function)	•	•	single
LG.LA65.5572.01.153	Escape Lock	•	•	single
LG.LA68.5500.01.153	Roller Bolt Deadlock	•	•	single
NFR LG.LA80.5572.01.153	Sashlock Single			

OTHER LOCKS AND LACHES

A series of tubular, mortice or roller latches for timber doors



Latches, Catches & Bolts

Item no.	Description	Finishes		Unit
		SS	PS	
LG.LA50.057.01.153	WC deadbolt - 8mm spindle	•	–	single
LG.LA403.00.01.153	Adjustable roller catch	•	–	single
LG.LA408.03 & 04.150	Door bolt c/w key & strike	•	–	single

Tubular mortice latches for timber doors available to order



All dimensions are shown in mm

10 Year Guarantee

▶ Refer page No. 17 & 18 for Codes, Grades & Finishes

CYLINDERS & ESCUTCHEONS

CYLINDERS

A series of euro profile cylinders for use with Standard or Fire Rated cylinder locks

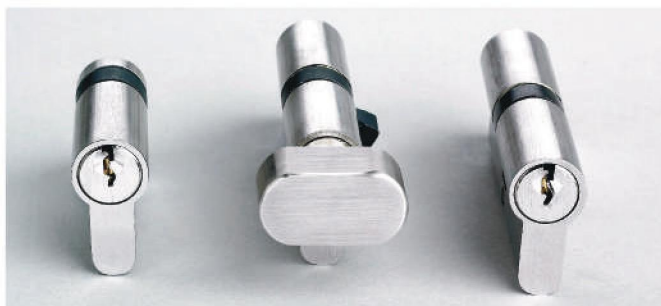

Standard Locks

Item no.	Cylinder Type	Length	Unit
LG.LA202E.60.5.04	Euro Profile - Double	60mm	single
LG.LA202E.70.5.04	Euro Profile - Double	70mm	single
LG.LA202E.80.5.04	Euro Profile - Double	80mm	single
LG.LA202E.90.5.04	Euro Profile - Double	90mm	single
LG.LA201E.60.5.04	Euro Profile - Cyl & Turn	60mm	single
LG.LA201E.70.5.04	Euro Profile - Cyl & Turn	70mm	single
LG.LA201E.80.5.04	Euro Profile - Cyl & Turn	80mm	single
LG.LA201E.90.5.04	Euro Profile - Cyl & Turn	90mm	single
LG.LA203E.70.5.04	Euro Profile - WC Cylinder	70mm	single
LG.LA200E.45.5.04	Euro Profile - Single Cylinder	45mm	single
LG.LA200E.50.5.04	Euro Profile - Single Cylinder	50mm	single
LG.LA200A.25.04.150	Cylinder Adapter	25mm	single
LG.LA204E.45.5.04	Euro Profile - Single Turn Only	45mm	single
LG.LA200E.45.BL.04	Euro Profile - Blank Cylinder	45mm	single

- ▶ Euro profile standard differ cylinders in either 5 or 6 pin configurations
- ▶ Choice of cylinder lengths to suit different door and hardware
- ▶ Satin Nickel Plated finish (SNP) as standard
- ▶ Standard cylinders supplied complete with 3 keys each
- ▶ Masterkey systems to suit client requirements including non-EN 1303 5/6 pin cylinders for lower budget contracts.

FIRE RATED CYLINDER LOCKS

EN1303 certified 6 pin cylinders Classification

1 - 6 - 0 - B - 0 - C - 6 - B/C/D with the benefits of

- ▶ Greater number of key combinations
- ▶ Patent protection for insurance purposes
- ▶ 100,000 cycles durability test
- ▶ Highest Grade 6 key security
- ▶ B/C/D attack resistance (with security escutcheon)

Available to Order

- ▶ Rim Cylinders
- ▶ Threaded Mortise Cylinders
- ▶ Padlocks
- ▶ All Euro Cylinders are also available in Oval Profile

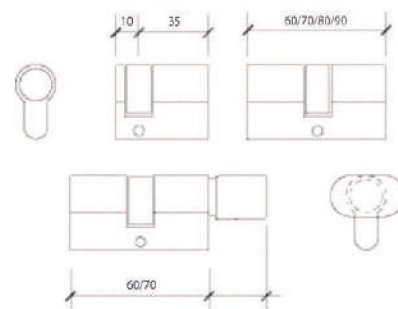

BATHROOM INDICATOR & TURNS

- ▶ A rose mounted indicator & turn for use with bathroom locks
- ▶ Available in 8mm or 5mm rose depth
- ▶ Also available with an extended turn for the less able
- ▶ Each turn supplied with appropriate indicator
- ▶ 8mm spindle supplied
- ▶ Supplied with face fixings
- ▶ SS & PS finishes are available



Bathroom Indicator & Turns

Item no.	Function	Depth	Finishes		Unit
			SS	PS	
LG.LA18.5.005.01.153	Standard turn	5	•	•	set
LG.LA18.008.01.153	Standard turn	8	•	•	set
LG.LA18.5D.005.01.153	Extended turn	5	•	•	set
LG.LA18D.008.01.153	Extended turn	8	•	•	set

10 Year Guarantee

- ▶ Refer page No. 17 & 18 for Codes, Grades & Finishes

ESCUTCHEONS

- ▶ A series of escutcheons with concealed fixings for use with rose mounted levers
- ▶ Available in 8mm or 5mm depth
- ▶ Supplied with face fixings
- ▶ SS & PS finishes are available

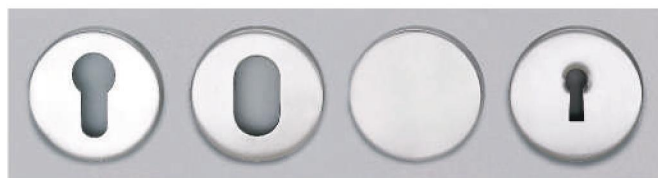

Escutcheons

Item no.	Function	Depth	Finishes		Unit
			SS	PS	
LG.LA17.008.01.153	Euro profile	8	•	•	single
LG.LA17.5.008.01.153	Euro profile	5	•	•	single
LG.LA170V.008.01.153	Oval profile	8	•	•	single
LG.LA17.50V.008.01.153	Oval profile	5	•	•	single
LG.LA17LK.008.01.153	Lever key	8	•	•	single
LG.LA17.5LK.008.01.153	Lever key	5	•	•	single
LG.LA17BL.008.01.153	Blank	8	•	•	single
LG.LA17.5BL.008.01.153	Blank	5	•	•	single

PANIC EXIT HARDWARE

PANIC EXIT HARDWARE

A series of touch and push bar panic exit devices offering single or double point latching.



- ▶ Stainless steel construction
- ▶ Vertical rods with Pullman type latches
- ▶ UL Listed / CE marked
- ▶ Hold back function available
- ▶ External access by lever or knob
- ▶ Suits doors 50mm to 64mm thick (extended spindles available for doors 50-1050mm)

PANIC HARDWARE OPTIONS

100SERIES

Standard Touch Bar Exit Devices to UL 305, ANSI/BHMA A 156.3 Grade 1.

Maximum unit width 1050mm (cut to size at site). Maximum door weight 200kg. Non fire rated.



- ▶ **LG.LAPH.001.01.153- SSS | LG.LAPH.001.16.150- SILVER**
Touch Bar Panic Latch with single point latching, stainless steel latch with anti-thrust bolt. Reversible (non-handed).
- ▶ **LG.LAPH.002.01.153- SSS | LG.LAPH.002.16.150- SILVER**
As LG.LAPH.001 but with full length touch bar
- ▶ **LG.LAPH.003.01.153- SSS | LG.LAPH.003.16.150- SILVER**
As LG.LAPH.001 but with Hold Back Catch (latch bolt dogging) - not for use on fire doors
- ▶ **LG.LAPH.006.01.153- SSS | LG.LAPH.006.16.150- SILVER**
Touch Bar Vertical Rod Device with top/bottom latching. Stainless steel Pullman-type latches. For doors 2133mm high (extended top rods available for doors to 3000mm height)

PANIC HARDWARE OPTIONS

300SERIES

Touch Bar Exit Devices to EN 1125, CE marked and fire tested to EN 1634-

1 for use on FD60 timber doors. CE Classification 3-7-6-1-1-4-2-2-B-A/C. Maximum door weight 200kg.

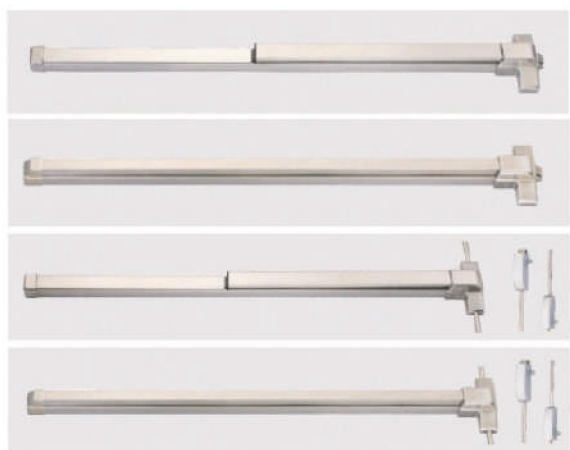

- ▶ **LG.LAPH.301S- SSS | LG.LAPH.301P- SILVER**
Touch Bar Panic Latch with single point latching, stainless steel latch with anti-thrust bolt. Reversible (non-handed).
- ▶ **LG.LAPH.302S- SSS | LG.LAPH.302P- SILVER**
As LG.LAPH.301 but with full length touch bar
- ▶ **LG.LAPH.306S- SSS | LG.LAPH.306P- SILVER**
Touch Bar Vertical Rod Device with top/bottom latching. Stainless steel Pullman-type latches. For doors 2133mm high (extended top rods available for doors to 3000mm height)
- ▶ **LG.LAPH.307S- SSS | LG.LAPH.307P- SILVER**
As LG.LAPH.306 but with full length touch bar

10 Year Guarantee

- ▶ Refer page No. 17 & 18 for Codes, Grades & Finishes

PANIC EXIT HARDWARE

PANIC HARDWARE OPTIONS

400 SERIES

Touch Bar Exit Devices to UL 305 and UL 1 OC for use on FD90 steel doors. Maximum door weight 200kg.

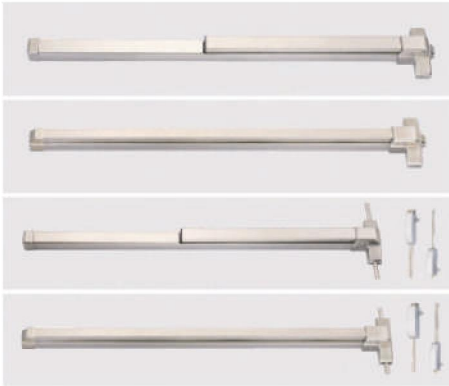

- ▶ **LG.LAPH.401F.01.153-SSS | LG.LAPH.401F.16.150 - SILVER**
Touch Bar Panic Latch with single point latching, stainless steel latch with anti-thrust bolt. Reversible (non-handed).
- ▶ **LG.LAPH.402F.01.153-SSS | LG.LAPH.402F.16.150 - SILVER**
As LG.LAPH.401 but with full length touch bar
- ▶ **LG.LAPH.406F.01.153-SSS | LG.LAPH.406F.16.150 - SILVER**
Touch Bar Vertical Rod Device with top/bottom latching. Stainless steel Pullman-type latches. For doors 2133mm high (extended top rods available for doors to 3000mm height)
- ▶ **LG.LAPH.407F.01.153-SSS | LG.LAPH.407F.16.150 - SILVER**
As LG.LAPH.406 but with full length touch bar

PANIC HARDWARE OPTIONS

500 SERIES

Push Bar Panic Exit Device to EN 1125 CE marked and fire tested to EN 1634-1 for use on FD60 timber doors. CE Classification 3-7- 6-1-1-4-2-1-B-NC. Maximum door weight 200kg.

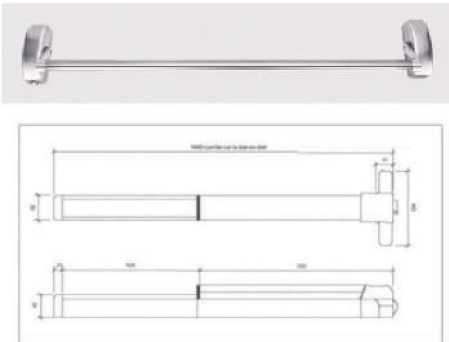

- ▶ **LG.LAPH.501S-SSS | LG.LAPH.501P - SILVER**
Push Bar Panic Latch with single point latching, stainless steel latch with anti-thrust bolt. Reversible (non-handed).
- ▶ **LG.LAPH.505S-SSS | LG.LAPH.505P - SILVER**
Push Bar Mortice Panic Latch with euro profile cylinder mortiselock
- ▶ **LG.LAPH.506S-SSS | LG.LAPH.506P - SILVER**
Push Bar Vertical Rod Device with top/bottom latching. Stainless steel Pullman-type latches. For doors 2133mm high (extended top rods available for doors to 3000mm height)

Additional Devices available to order only:

- ▶ Push Pad Devices - latch and vertical rod options
- ▶ Fixing Kits for Glass Doors
- ▶ Devices with micro switch for use with access control systems

ACCESSORIES

- ▶ **LG.LAPH.008.01.153**
External access lever trim unit. Rose mounted key-in-lever type for use with LG.LAPH panic exit hardware. Key locks/unlocks the lever handle. Inside touch bar is always free to escape. Finish SSS as standard NOT SUITABLE FOR MASTERKEYING
- ▶ **LG.LAPH.009.01.153 / LG.LAPH.009K.01.153 & LG.LAPH.0098.01.153** (without cylinder hole)
External access lever/knob trim unit for use with LG.LAPH panic exit hardware. Key locks/unlocks the lever/knob handle. Inside touch bar is always free to escape finish SSS as standard SUITABLE FOR MASTERKEYING
- ▶ **LG.LAPH.01 0.01.153** - External access knob trim unit. Rose mounted key-in knob type for use with LG.LAPH panic exit hardware. Key locks/unlocks knob. Inside touch bar always free to escape. Not suitable for Master Keying. Finish SSS as standard
- ▶ **LG.LAPH.DDS.01.153** - Double Door Strike Plate-For use on double doors with Flush or rebated meeting stiles



All dimensions are shown in mm

- ▶ Refer page No. 17 & 18 for Codes, Grades & Finishes

HONESTY

RELIABILITY

INTEGRITY

PERFECT FOR...



LEVER FURNITURE

LEVER ASSEMBLIES



The essence of the Laidlaw Gulf Contract range is a series of lever handles which are supplied pre-fixed to the rose mounting. These assemblies give specifiers and installers the benefits of:

- ▶ Simplified specification with complete lever and rose assemblies with spindle and fixings
- ▶ Easier and quicker installation
- ▶ Greater accuracy of installation
- ▶ Improved strength and durability

Contract Range lever handle assemblies have the following features

- ▶ All levers are circlip fixed to the rose inner
- ▶ Improved 3 point fixing
- ▶ Levers pre-fixed to rose
- ▶ Secure M4 bolt through rose fixings at 38mm centres
- ▶ Grub screw fixing into spindle
- ▶ Supplied with M4 bolt through fixings for back to back assembly and optional face fixing screws
- ▶ Snap on rose cover conceals fixings
- ▶ Fixing centres (38mm) compatible with all major lockcase ranges
- ▶ Spindles for specific applications are available

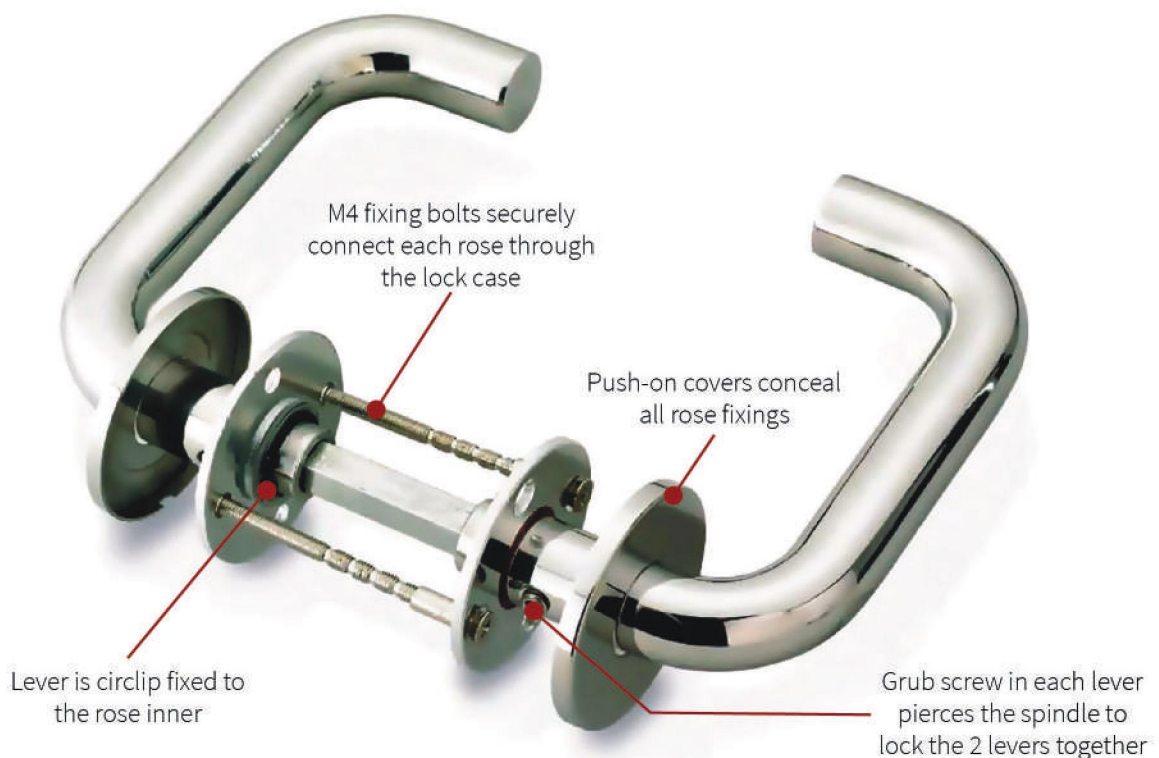

LEVER FURNITURE

LEVER HANDLES - ROSE MOUNTED

Round bar 'return to door' lever pre-fixed to a sprung rose

Supplied with 'bolt through' and face fixings

Metal inner rose | 8mm spindle supplied

Conforms to the dimensional requirements of BS8300 for DDA Applications

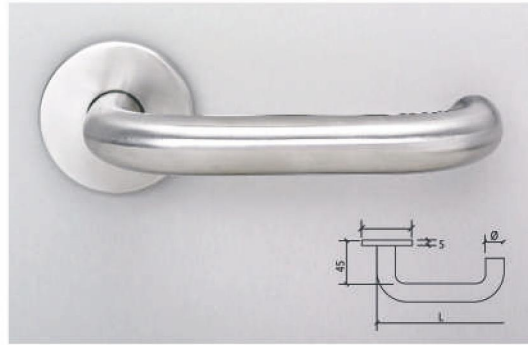
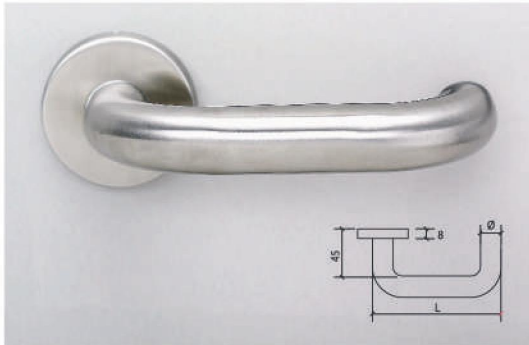

Item no.	Ø	L	Finishes		Unit
			SS	PS	
LG.LA02.140.01.153 Lever handle	19	140	•	•	pair
LG.LA10.140.01.153 Lever handle	22	140	•	•	pair

Item no.	Ø	L	Finishes		Unit
			SS	PS	
LG.LA02.5.140.01.153 Lever handle	19	140	•	•	pair
LG.LA10.5.140.01.153 Lever handle	22	140	•	•	pair

LEVER HANDLES - ROSE MOUNTED

Stainless steel lever handles on 8mm sprung rose.

Levers are pre-fixed to the rose inner with push on rose covers to conceal fixings

Available in Satin (SS) | Polished (PS) finish available to order

Supplied with bolt through back to back fixings and alternative face fixings

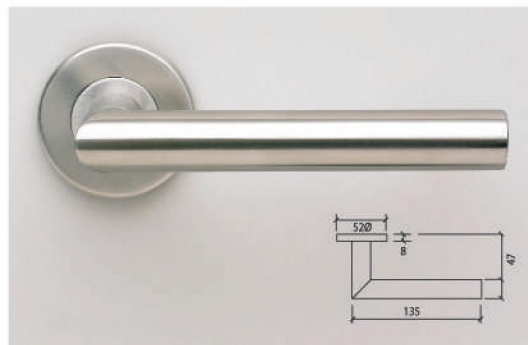
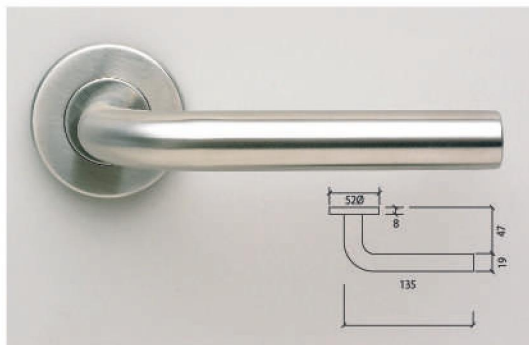

Item no.	Description	SS	PS	Unit
LG.LA130.137.01.153 Straight round bar lever		•	•	pair

Item no.	Description	SS	PS	Unit
LG.LA131.137.01.153 "Mitred" straight lever		•	•	pair

All dimensions are shown in mm

5 Year Guarantee

► Refer page No. 17 & 18 for Codes, Grades & Finishes

LEVER FURNITURE

LEVER HANDLES - ROSE MOUNTED

A special edition series of stylish stainless steel lever handles on 8mm sprung rose.

Levers are pre-fixed to the rose inner with push on rose covers to conceal fixings

Available in Satin (SS) | Polished (PS) finish available to order

Supplied with bolt through back to back fixings and alternative face fixings



		SS	PS	Unit
Item no.	LG. LA132.137.01.153			
description	"Arched" straight lever	•	•	pair



		SS	PS	Unit
Item no.	LG. LA133.137.01.153			
description	"T" straight lever	•	•	pair



		SS	PS	Unit
Item no.	LG. LA134.137.01.153			
description	"Mitred" return to door lever	•	•	pair



		SS	PS	Unit
Item no.	LG. LA135.133.01.153			
description	"ARC Form" rounded lever	•	•	pair

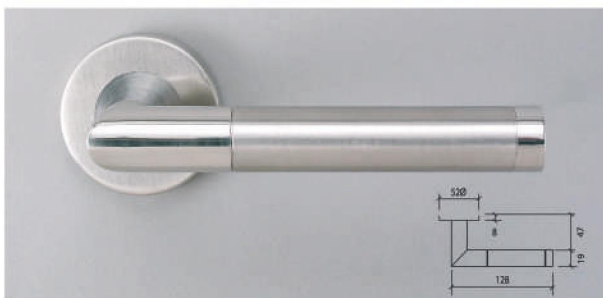

		DSP	Unit
Item no.	LG. LA136.128.01.153		
description	"Duo Finish" Mitre straight lever	•	pair



		SS	PS	Unit
Item no.	LG. LA137.133.01.153			
description	"S" straight lever	•	•	pair

All dimensions are shown in mm

5 Year Guarantee

► Refer page No. 17 & 18 for Codes, Grades & Finishes

LEVER FURNITURE

SOLID SECTION LEVER HANDLES-ROSE MOUNTED

A special edition series of stylish stainless steel lever handles on 8mm sprung rose.

Lever handles are pre-fixed to the rose inner with push on rose covers to conceal fixings

Available in Satin (SS) | Polished (PS) finish available to order

Supplied with bolt through back to back fixings and alternative face fixings



		SS	PS	Unit
Item no.	LG. LA170.127.01.153			
Description	"Gullwing" lever	•	•	pair



		SS	PS	Unit
Item no.	LG. LA171.136.01.153			
Description	"Curved" semi solid lever	•	•	pair

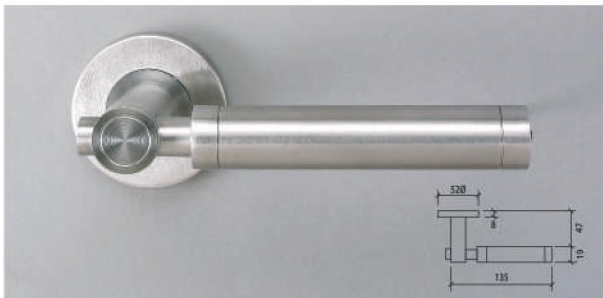

		SS	PS	Unit
Item no.	LG. LA172.135.01.153			
Description	Straight semi solid lever	•	•	pair

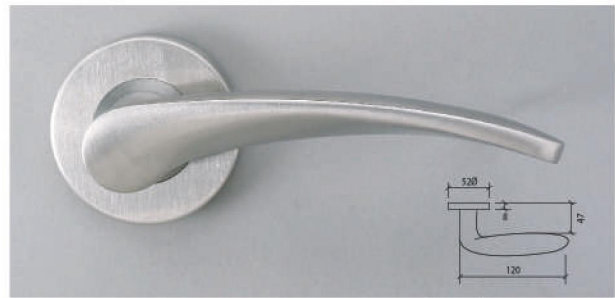

		SS	PS	Unit
Item no.	LG. LA173.120.01.153			
Description	Wing Type lever	•	•	pair

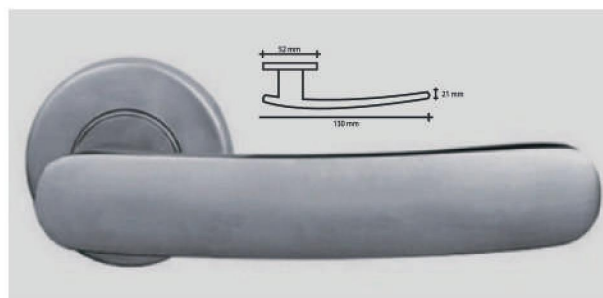

Item no.	Description
LG LA175.130.01.153	LEVER HANDLE "CURVED TYPE SOLID LEVER"
	52mm diameter x 8mm thick rose Supplied with bolt through back to back fixing and 8mm square spindle Suitable for 38-54mm thick doors Stainless Steel Grade 304

SPINDLES & FIXINGS

All lever and rose variants are supplied as standard with a spindle suitable for doors 38mm to 54mm thick. Levers can be supplied as half sets to order in addition to the following spindle options.

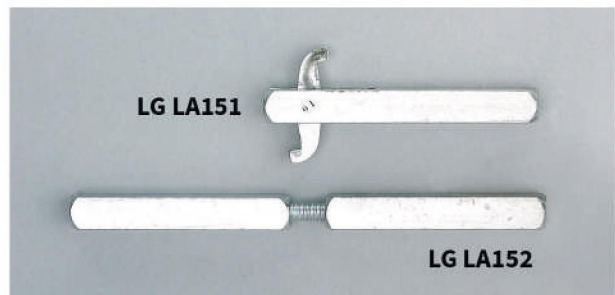

Item no.	Description
LA151	Half spindle to operate
LA152	Split spindle for locks with split follower
LA154	Bolt through fixing pack for lever sets
LA153	Fixed dead / Tailor Spindle
LA154	Standard Spindle 130 X MM
LA155	External Trim Cross / Square Spindle

5 Year Guarantee

▶ Refer page No. 17 & 18 for Codes, Grades & Finishes

LEVER FURNITURE



Item no.	Description	Finishes
LG LA54 202.6	"Flat" investment cast lever and square SL rose	SS, PS

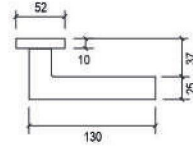

Item no.	Description	Finishes
LG LA54 203.6	"Cigar" investment cast lever on SL rose	SS, PS

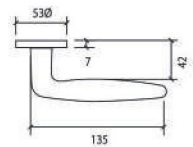

Escutcheons to compliment the LG.LA 54 202 lever style, square escutcheons for Cylinders. Bathroom turns and emergency releases are also available.



Item no.	Description	Finishes
LG LA51 202.3	Euro profile cyl escutcheon	SS, PS
LG LA51 202.04/5	Bathroom turn & indicator	SS, PS

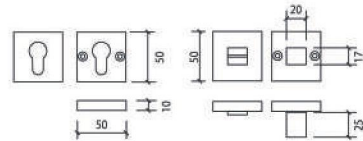

Item no.	Description	Finishes
LG LA54 204.6	"Flat" investment cast lever on SL rose	SS, PS

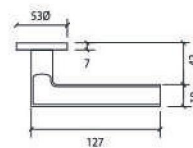

Item no.	Description	Finishes
LG LA54 206.6	"Tapered" investment cast lever on SL rose	SS, PS

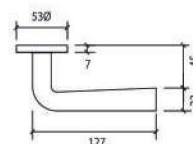

5 Year Guarantee

► Refer page No. 17 & 18 for Codes, Grades & Finishes

LEVER FURNITURE

LEVER HANDLES - PLATE MOUNTED

LG.LA 174.170.01.153 and LG.LA 175.130.01.153 Lever Furniture have the following features.

- ▶ Sprung roses or backplates suitable for lightly sprung locks and tubular latches
- ▶ Concealed bolt through fixings
- ▶ Matching escutcheons for Euro profile cylinders, Oval cylinders, Lever Key functions where stated
- ▶ Latch Plate and Bathroom lock Backplates
- ▶ Satin, polished or combination finishes (see lever types)
- ▶ Grub screw fixing into 8mm slotted spindle

In addition to the standard features, all rose fixed lever styles are supplied with an inner rose which has multiple fixing points. This allows for bolt through fixings either on the horizontal or vertical axis.



Item no.	Description	Finishes
LG LA174E.170.01.153	19mm LEVER HANDLE ON PLATE	SS
	Prepared with Euro profile cylinder hole Stainless Steel Grade 304	

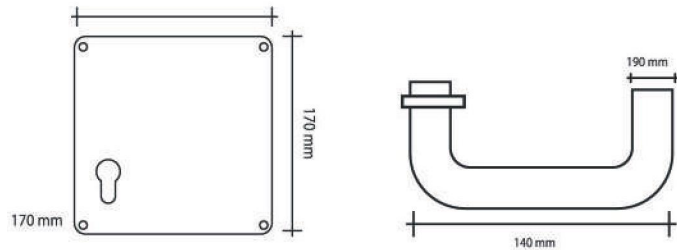

LEVER HANDLE ON RECTANGULAR ROSE



LG.LA10EO.169.01.153

- ▶ 22mm diameter lever handle,
- ▶ Pre-fixed to an oval rose size 45mm X 169mm X 8mm.
- ▶ Conforms to the dimensional requirements of BS 8300 for DDA application
- ▶ With matching oval escutcheons to conceal fixing screws
- ▶ Supplied with bolt through & face fixing and 8mm square spindle
- ▶ Suitable for 38 to 54mm thick doors
- ▶ Stainless Steel Grade 304, Satin finish

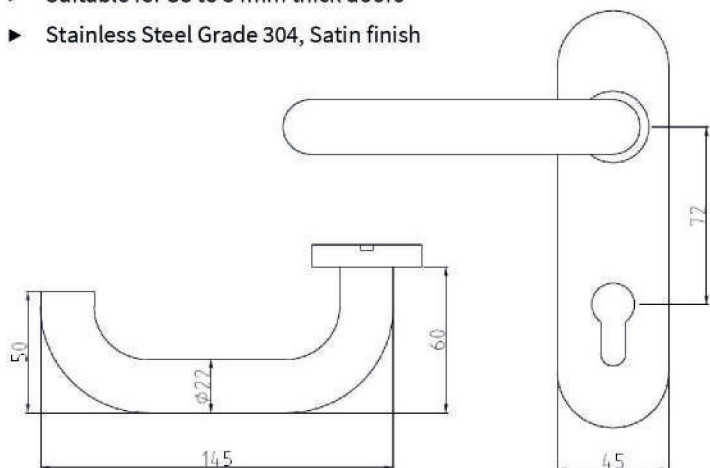

All dimensions are shown in mm

5 Year Guarantee

▶ Refer page No. 17 & 18 for Codes, Grades & Finishes

'ANIQ RANGE LEVER FURNITURE

WELCOME TO 'ANIQ.

Here is a brief selection of our new range of elegant lever handles. Designed with aesthetics in mind and to match any design requirements, these are the premium lever handles for the MENA region and beyond. Perfect for residential and 5* hospitality projects, these handles come in a variety of styles and finishes and are manufactured to the highest possible standards. If your perfect design isn't in this selection, we can source it for you from our global supply chain. Simply let us know in person or email us a photograph at info@laidlaw.ae

'ANIQ RANGE LEVER FURNITURE



Item no.	Ø	L	Finishes		Unit
			SS	PS	
LG.LA3037.135.04.150 Lever Handle					Pair

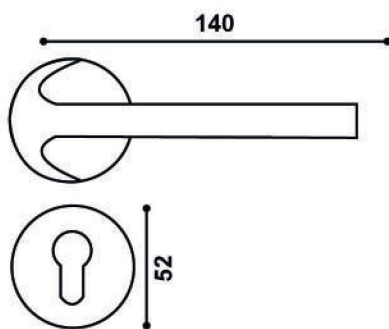

LEVER HANDLE FEATURES

- ▶ Solid Lever handle
- ▶ 135mm length
- ▶ Zinc alloy base material
- ▶ Supplied with 8mm square spindle and back to back fixings
- ▶ Suitable for 38mm to 54mm thick doors
- ▶ Satin Nickel Plated finish

All dimensions are shown in mm

5 Year Guarantee

- ▶ Refer page No. 17 & 18 for Codes, Grades & Finishes

'ANIQ RANGE

LEVER FURNITURE

LEVER HANDLE

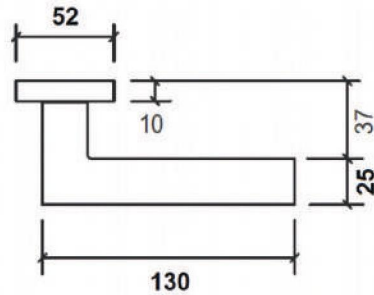

Item no.	Ø	L	Finishes		Unit
			SS	PS	
LG.LA54.202.6 L/R					Pair

FEATURES

- ▶ 130mm length Solid Cast Lever handle
- ▶ 52mm X 52mm X 10 escutcheons
- ▶ Stainless Steel Grade 304, Satin finish
- ▶ Supplied with 8mm square spindle and bolt through fixings
- ▶ Suitable for 38 to 54mm thick doors

LEVER HANDLE

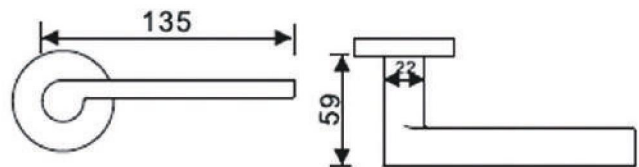

Item no.	Ø	L	Finishes		Unit
			SS	PS	
LG.LA321.135.01.153					Pair

FEATURES

- ▶ Investment cast solid lever handle with round rose
- ▶ 135mm length
- ▶ Supplied with back to back fixings
- ▶ Suitable for 38mm to 54mm thick doors
- ▶ Stainless Steel Grade 304, Satin finish

All dimensions are shown in mm

5 Year Guarantee

▶ Refer page No. 17 & 18 for Codes, Grades & Finishes

'ANIQ RANGE

LEVER FURNITURE

LEVER HANDLE

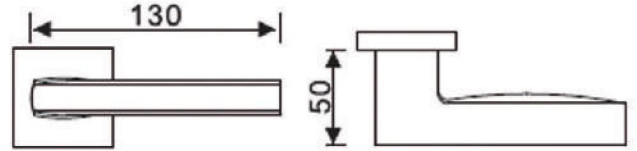
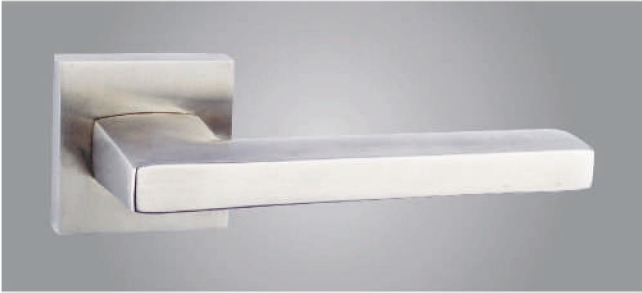

Item no.	Ø	L	Finishes		Unit
			SS	PS	
LG.LA328.130.01.153					Pair

FEATURES

- ▶ 130mm length
- ▶ Investment cast, solid with Brass insert
- ▶ Supplied with 8mm square spindle and back to back fixings
- ▶ Square stamped escutcheons
- ▶ Suitable for 38mm to 54mm thick doors
- ▶ Stainless Steel Grade 304, Satin finish

LEVER HANDLE

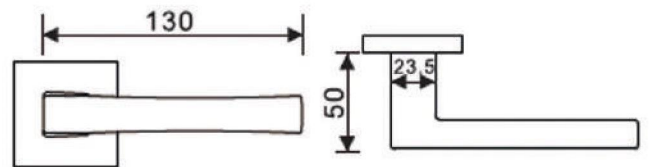
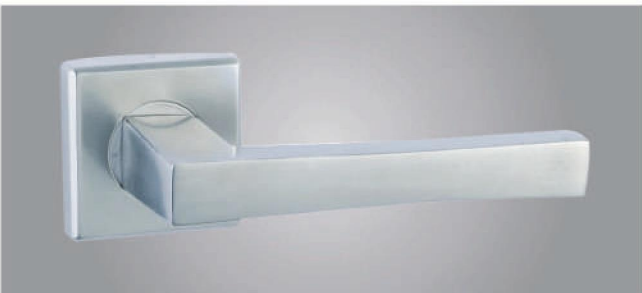

Item no.	Ø	L	Finishes		Unit
			SS	PS	
LG.LA3014.130.01.153					Pair

FEATURES

- ▶ 130mm length
- ▶ Investment cast, solid with Brass insert
- ▶ Supplied with 8mm square spindle and back to back fixings
- ▶ Square stamped escutcheons
- ▶ Suitable for 38mm to 54mm thick doors
- ▶ Stainless Steel Grade 304, Satin finish

All dimensions are shown in mm

5 Year Guarantee

- ▶ Refer page No. 17 & 18 for Codes, Grades & Finishes

'ANIQ RANGE

LEVER FURNITURE

LEVER HANDLE

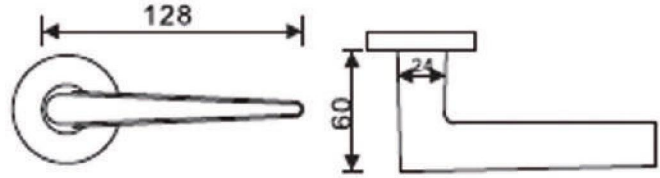

Item no.	Ø	L	Finishes		Unit
			SS	PS	
LG.LA3016.128.01.153					Pair

FEATURES

- ▶ 128mm length
- ▶ Investment cast, solid with Brass insert
- ▶ Supplied with 8mm square spindle and back to back fixings
- ▶ Round stamped escutcheons
- ▶ Suitable for 38mm to 54mm thick doors
- ▶ Stainless Steel Grade 304, Satin finish

LEVER HANDLE

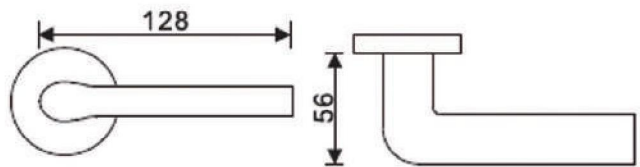

Item no.	Ø	L	Finishes		Unit
			SS	PS	
LG.LA3017.128.01.153					Pair

FEATURES

- ▶ 128mm length
- ▶ Investment cast, solid with Brass insert
- ▶ Supplied with 8mm square spindle and back to back fixings
- ▶ Round stamped escutcheons
- ▶ Suitable for 38mm to 54mm thick doors
- ▶ Stainless Steel Grade 304, Satin finish

All dimensions are shown in mm

5 Year Guarantee

▶ Refer page No. 17 & 18 for Codes, Grades & Finishes

'ANIQ RANGE

LEVER FURNITURE

LEVER HANDLE

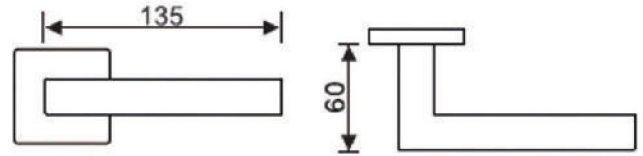
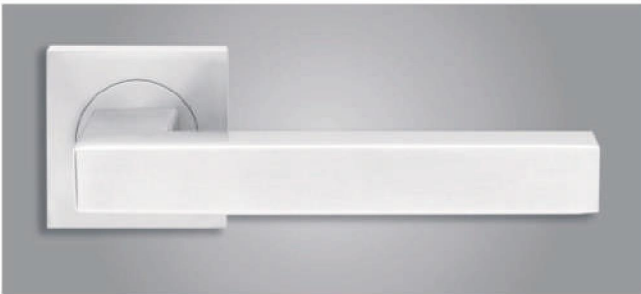

Item no.	Ø	L	Finishes		Unit
			SS	PS	
LG.LA3018.135.01.153					Pair

FEATURES

- ▶ 135mm length
- ▶ Investment cast, solid with Brass insert
- ▶ Supplied with 8mm square spindle and back to back fixings
- ▶ Square stamped escutcheons
- ▶ Suitable for 38mm to 54mm thick doors
- ▶ Stainless Steel Grade 304, Satin finish

LEVER HANDLE

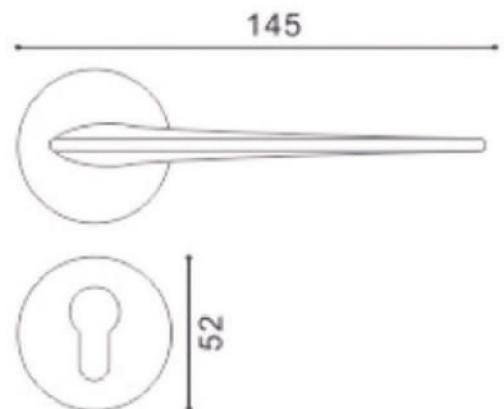
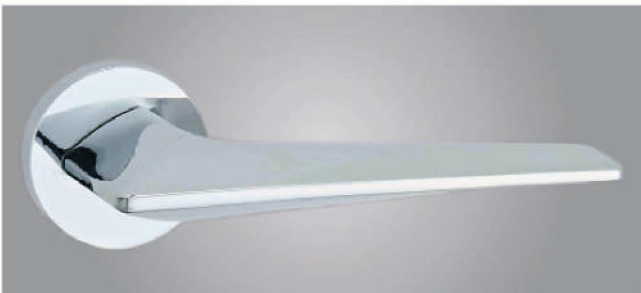

Item no.	Ø	L	Finishes		Unit
			SS	PS	
LG.LA3019.135.05.150					Pair

FEATURES

- ▶ 130mm length
- ▶ Investment cast, solid with Brass insert
- ▶ Supplied with 8mm square spindle and back to back fixings
- ▶ Square stamped escutcheons
- ▶ Suitable for 38mm to 54mm thick doors
- ▶ Stainless Steel Grade 304, Satin finish

All dimensions are shown in mm

5 Year Guarantee

▶ Refer page No. 17 & 18 for Codes, Grades & Finishes

'ANIQ RANGE

LEVER FURNITURE

LGAI RANGE DESIGNER LEVER HANDLE

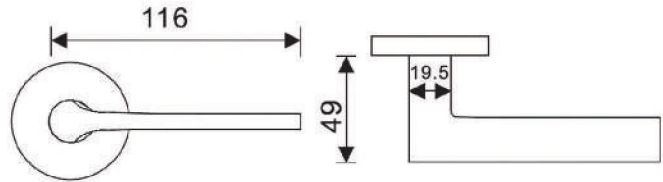

Item no.	Ø	L	Finishes		Unit
			SS	PS	
LG.LA3033.116.04.150 Lever Handle					Pair

FEATURES

- ▶ Solid Lever handle
- ▶ Zinc alloy base material
- ▶ Size: 10mm x 20mm x 116mm
- ▶ Supplied with fixings back to back and 8mm square spindle
- ▶ Satin Nickel Plated finish

LEVER HANDLE

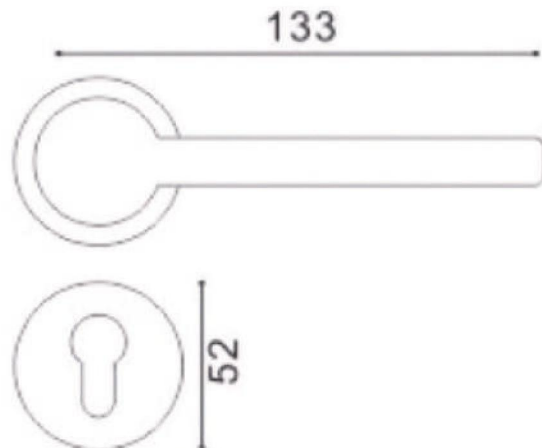

Item no.	Ø	L	Finishes		Unit
			SS	PS	
LG.LA3034.135.04.150					Pair

FEATURES

- ▶ Solid Lever handle
- ▶ 135mm length
- ▶ Zinc alloy base material
- ▶ Supplied with 8mm square spindle and back to back fixings
- ▶ Suitable for 38mm to 54mm thick doors
- ▶ Satin Nickel Plated finish

All dimensions are shown in mm

5 Year Guarantee

▶ Refer page No. 17 & 18 for Codes, Grades & Finishes

'ANIQ RANGE

LEVER FURNITURE

LEVER HANDLE

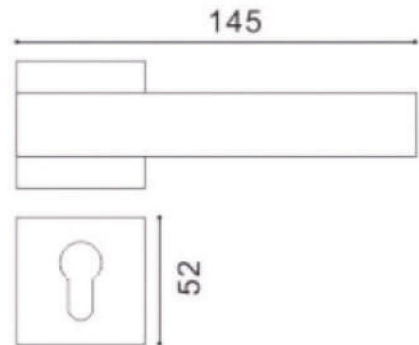
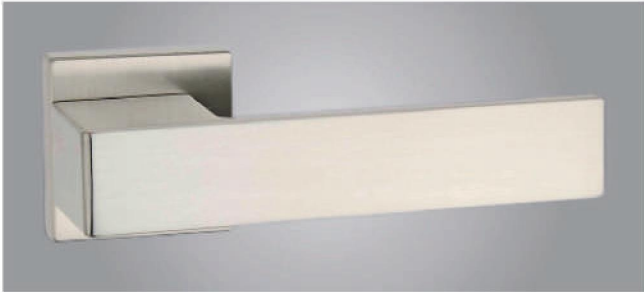

Item no.	Ø	L	Finishes		Unit
			SS	PS	
LG.LA3035.135.04.150					Pair

FEATURES

- ▶ Rectangular profile Solid Lever handle
- ▶ 135mm length
- ▶ Zinc alloy base material
- ▶ Supplied with 8mm square spindle and back to back fixings
- ▶ Suitable for 38mm to 54mm thick doors
- ▶ Satin Nickel Plated finish

LEVER HANDLE

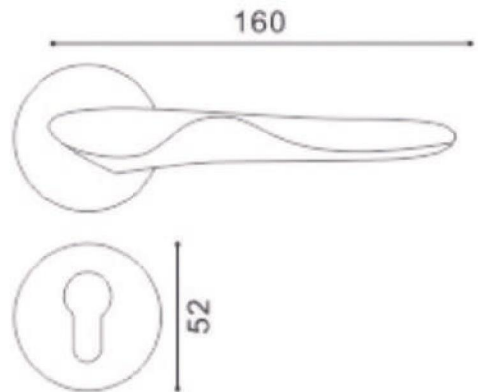

Item no.	Ø	L	Finishes		Unit
			SS	PS	
LG.LA3036.135.08.150					Pair

FEATURES

- ▶ Solid Designer Lever handle
- ▶ 135mm length
- ▶ Zinc alloy base material
- ▶ Supplied with 8mm square spindle and back to back fixings
- ▶ Suitable for 38mm to 54mm thick doors
- ▶ Black Matt finish

All dimensions are shown in mm

5 Year Guarantee

- ▶ Refer page No. 17 & 18 for Codes, Grades & Finishes

PULL HANDLES

PULL HANDLES

A series of round bar pull handles for single bolt through fixing, or in pairs fixed back to back

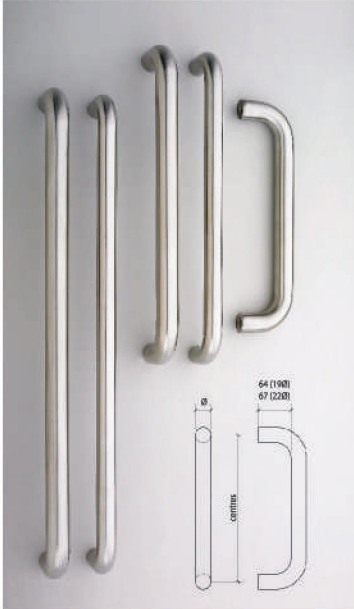

- ▶ Supplied complete with fixings to suit timber doors
- ▶ Back-to-back fixings for glass & timber doors
- ▶ Available in 19mm and 22mm diameters
- ▶ For push/pull applications select an appropriate push plate for the other side of the door
- ▶ SS & PS finishes are Grade 304 Other finishes to order
- ▶ Pull handles of 450mm centres and above meet the requirements of BS 8300 for DDA applications
- ▶ Spare bolt through fixing packs are available (see below)
- ▶ Face fixing roses also available (see below)

LG.LA05P.225.01.153

Pull handle 19mm dia x 225mm centres mounted on backplate 300mm x 100mm. Plain Backplate

LG.LA05EP.225.01.153

Pull handle 19mm dia x 225mm centres mounted on backplate 300mm x 100mm. Plate is engraved 'PULL'.



Bolt Through

Item no.	Description	Ø	Centres	Finishes		Unit
				SS	PS	
LG.LA126.150.01.153	Pull Handle	19	150	•	•	single
LG.LA05.225.01.153	Pull Handle	19	225	•	•	single
LG.LA06..300.01.153	Pull Handle	19	300	•	•	single
LG.LA77.425.01.153	Pull Handle	19	425	•	•	single
LG.LA100.600.01.153	Pull Handle	19	600	•	•	single
LG.LA13.225.01.153	Pull Handle	22	225	•	•	single
LG.LA14.300.01.153	Pull Handle	22	300	•	•	single
LG.LA80.425.01.153	Pull Handle	22	425	•	•	single
LG.LA102.600.01.153	Pull Handle	22	600	•	•	single

Back to Back

Item no.	Description	Ø	Centres	Finishes		Unit
				SS	PS	
LG.LA 127.150.01.153	Pull Handle	19	150	•	•	single
LG.LA07.225.01.153	Pull Handle	19	225	•	•	single
LG.LA08.300.01.153	Pull Handle	19	300	•	•	single
LG.LA78.425.01.153	Pull Handle	19	425	•	•	single
LG.LA101.600.01.153	Pull Handle	19	600	•	•	single
LG.LA15.225.01.153	Pull Handle	22	225	•	•	single
LG.LA16.300.01.153	Pull Handle	22	300	•	•	single
LG.LA81.425.01.153	Pull Handle	22	425	•	•	single
LG.LA 103.600.01.153	Pull Handle	22	600	•	•	single

PULL HANDLE ROSES

Fixing pack to convert bolt through fixing pull handles to concealed fixing surface mounted pulls



- ▶ 6mm surface fixed roses with concealed fixings
- ▶ Supplied complete with fixings for timber doors
- ▶ SS & PS finishes are Grade 304
- ▶ Must be ordered to suit 19, 22 or 25mm diameter pull handles

Concealed Fix Roses

Item no.	Ø	Depth	Finishes		Unit
			SS	PS	
LG.LA 116.006.01.153	19	6mm	•	•	single
LG.LA 117.006.01.153	22	6mm	•	•	single
LG.LA 118.006.01.153	25	6mm	•	•	single

▶ Refer page No. 17 & 18 for Codes, Grades & Finishes

PULL HANDLES

PULL HANDLES

A series of 'T' bar pull handles for single bolt through fixing or in pairs fixed back to back

Supplied complete with M8 fixings to suit timber doors

Back-to-back fixings for glass & timber doors | Available in 19, 25 and 30mm diameters

For push/pull applications select an appropriate push plate for the other side of the door

Pull handles of 450mm centres meet the requirements of BS 8300 for DDA applications

S & PS finishes are Grade 304 stainless steel | Grade 316 available to order

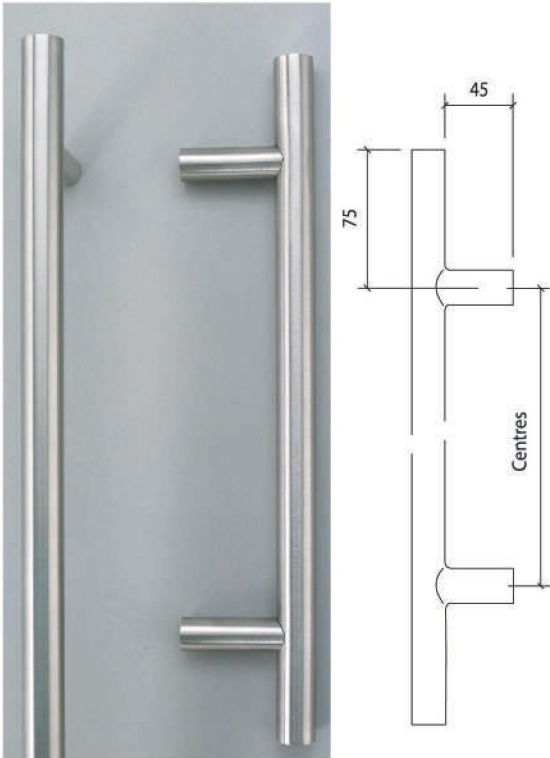

Bolt Through

Item no.	Description	Ø	Centres	Finishes		Unit
				SS	PS	
LG.LA320.225.01.153	Pull Handle	19	225	•	•	single
LG.LA321.300.01.153	Pull Handle	19	300	•	•	single
LG.LA322.425.01.153	Pull Handle	19	425	•	•	single
LG.LA323.600.01.153	Pull Handle	19	600	•	•	single
LG.LA326.300.01.153	Pull Handle	25	300	•	•	single
LG.LA327.425.01.153	Pull Handle	25	425	•	•	single
LG.LA328.600.01.153	Pull Handle	25	600	•	•	single
LG.LA329.900.01.153	Pull Handle	25	900	•	•	single

Back to Back

Item no.	Description	Ø	Centres	Finishes		Unit
				SS	PS	
LG.LA331.225.Q1.153	Pull Handle	19	225	•	•	pair
LG.LA332.300.01.153	Pull Handle	19	300	•	•	pair
LG.LA333.425.01.153	Pull Handle	19	425	•	•	pair
LG.LA334.600.01.153	Pull Handle	19	600	•	•	pair
LG.LA336.300.01.153	Pull Handle	25	300	•	•	pair
LG.LA337.425.01.153	Pull Handle	25	425	•	•	pair
LG.LA338.600.01.153	Pull Handle	25	600	•	•	pair
LG.LA339.900.01.153	Pull Handle	25	900	•	•	pair

PULL HANDLE FIXINGS

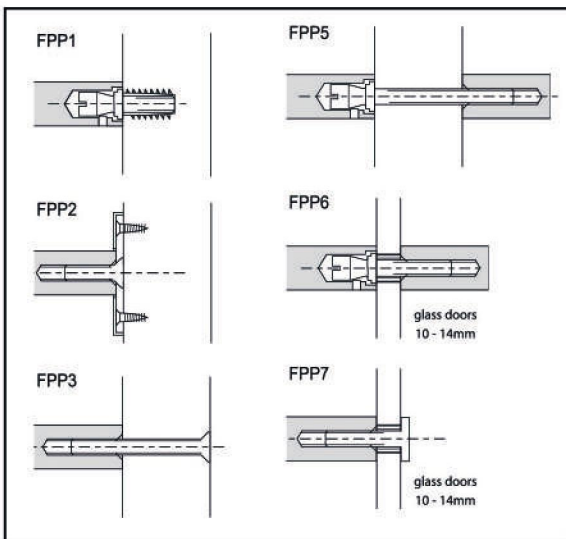

As standard, bolt through handles are supplied with fixings FPP3 and back to back handles are supplied with fixing pack FPP5 to suit up to 55mm thick doors. Alternative sizes and fixing types are also available.

FPP1 - Secret face facing for timbers doors with threaded plugs and M8 fixing bolts. For use with pin side pull handles only.

FPP2 - Concealed rose fixing (roses not included in fixing pack)

FPP3 - Bolt through fixing for timber doors with countersunk M8 bolts

FPP5 - Back to back fixing for timber doors 35 - 55mm.

FPP6 - Back to back fixing for glass doors with nylon bush and washers.

FPP7 - Bolt through fixing for glass doors with 'Pig nosed' bolt.

All dimensions are shown in mm

5 Year Guarantee

► Refer page No. 17 & 18 for Codes, Grades & Finishes

PULL HANDLES

PULL HANDLES

A series of shaped round bar pull handles for single bolt through fixing or in pairs fixed back to back

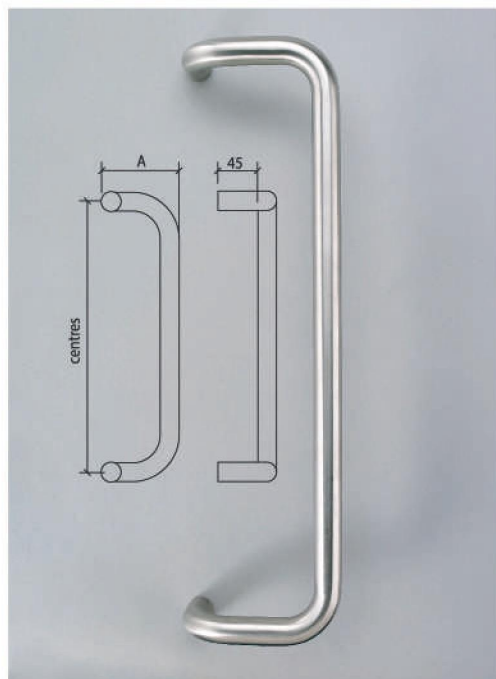

- ▶ Supplied complete with M8 fixings to suit timber doors
- ▶ Available in 19mm and 22mm diameters
- ▶ For push/pull applications select an appropriate push plate for the other side of the door
- ▶ SS & PS finishes are Grade 304 stainless steel
- ▶ Spare bolt through fixing packs are available (see below)
- ▶ Available to order only- specify size required from 300, 400 or 600mm centres

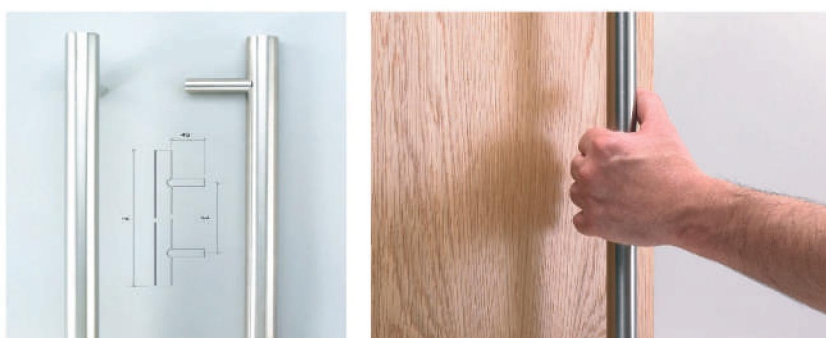

ENTRANCE PULL HANDLES

A series of pillar fixed round bar pull handles for single bolt through fixing or back to back



Mitred & Square Pull Handles

- ▶ Supplied complete with fixings to suit timber doors and metal doors
- ▶ Available in 25, 30 and 35mm diameters
- ▶ SS & PS finishes are Grade 304
- ▶ Spare bolt through fixing packs are available to order

Special Sizes

In addition to the pull handles shown we are also able to offer :

- ▶ 38mm pull handles - to order
- ▶ Special length handles - to order

Bolt Through- 25mm ø

Item no.	Dia - ø	A	C	Finishes		Unit
				SS	PS	
LG.LA341.120.01.153	250 Pull	1350	1200	•	•	single

BoltThrough - 30mm ø

Item no.	Dia - ø	A	C	Finishes		Unit
				SS	PS	
LG.LA346.120.01.153	300 Pull	1350	1200	•	•	single
LG.LA347.150.Q1.153	300 Pull	1650	1500	•	•	single
LG.LA348.180.01.153	300 Pull	1950	1800	•	•	single

Back to Back- 25mm ø

Item no.	Dia - ø	A	C	Finishes		Unit
				SS	PS	
LG.LA344.120.01.153	250 Pull	1350	1200	•	•	single

Back to Back- 30mm ø

Item no.	Dia - ø	A	C	Finishes		Unit
				SS	PS	
LG.LA351.120.01.153	300 Pull	1350	1200	•	•	single
LG.LA352.150.01.153	300 Pull	1650	1500	•	•	single
LG.LA353.180.01.153	300 Pull	1950	1800	•	•	single

All dimensions are shown in mm

5 Year Guarantee

- ▶ Refer page No. 17 & 18 for Codes, Grades & Finishes

FINGER PULLS

FLUSH PULLS

For sliding doors, or where a minimum projection is required, a recessed flush pull can be used



- ▶ LA27 is "screw fixed"
- ▶ LA28 is "concealed screw fixed"
- ▶ SS & PS finishes are Grade 304
- ▶ Grade 316 available to order.

Item no.	Dimensions	Finishes		Unit
		SS	PS	
LG.LA27.120.01.1 53 PULL	120mm x 40mm	•	•	single
LG.LA 27.125.01.153 PULL	125mm Ø x 82mm	•	•	single
LG.LA27.7070.01.1 53 PULL	70mm Ø x 70mm	•	•	single
LG.LA28.065.01.1 53 PULL	65mm Ø x 13mm	•	•	single
LG.LA28.090.01.1 53 PULL	90mm Ø x 13mm	•	•	single
LG.LA29.075.01.1 53 PULL	75mm Ø x 13mm	•	•	single

CYLINDER PULLS

For sliding doors, or where a minimum projection is required, a recessed flush pull can be used



- ▶ A series of cylinder pulls for use with cylinder nightlatches and deadlocks
- ▶ Thickness of pull 2mm
- ▶ SS & PS finishes are Grade 304
- ▶ Grade 316 available to order.

Item no.	Description	Finishes		Unit
		SS	PS	
LG.LA 19.000.01.153	Euro profile cylinder	•	•	single
LG. LA24.000.01.1 53	Lever key	•	•	single
LG. LA25.000.01.1 53	Oval profile cylinder	•	•	single
LG. LA26.000.01.1 53	Blank	•	•	single
LG. LA26.8.000.01.1 53	Rim cylinder	•	•	single

All dimensions are shown in mm

5 Year Guarantee

- ▶ Refer page No. 17 & 18 for Codes, Grades & Finishes

HONESTY

RELIABILITY

INTEGRITY

PERFECT FOR...



PUSH PLATES & PROTECTION PLATES

PUSH PLATES



- ▶ Push plates for use with bolt through pull handles
- ▶ Radius corners drilled & countersunk - supplied complete with screws
- ▶ Plate thickness 1.5mm
- ▶ SS & PS finishes are available in Grade 304 and 316

Push Plates

Item no.	Description	size(mm)	Finishes		Unit
			SS	PS	
LG.LA23.300.01.153	Plate	300 X 100	•	•	single
LG.LA23.400.01.153	Plate	400 X 100	•	•	single
LG.LA23E.300.01.153 PUSH ENGRAVED		300 X 100	•	•	single

Note : plates with square corners (as illustrated) bespoke sizes are available to order

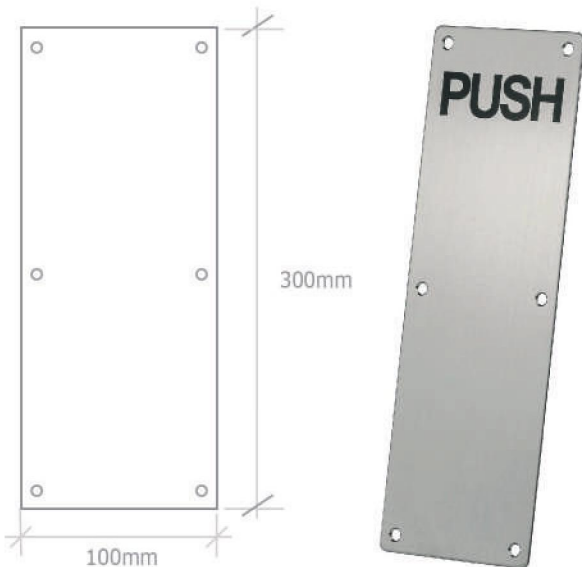

PROTECTION PLATES

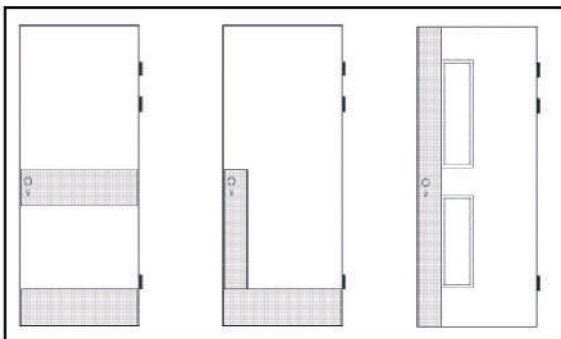

- ▶ Protection plates - specify size required
- ▶ Square or radiused corners drilled & countersunk - supplied complete with screws
- ▶ Plate thickness 1.5mm standard
- ▶ SS & PS finishes are Grade 304 or 316

Protection Plates

To order	Size (mm)	Finishes		Unit
		SS	PS	
Kick Plate - LG.LA23K		•	•	single
Mop Plate - LG.LA23M		•	•	single
Armour Plate - LG.LA23A		•	•	single
Midrail Plate - LG.LA23S		•	•	single

All dimensions are shown in mm

5 Year Guarantee

- ▶ Refer page No. 17 & 18 for Codes, Grades & Finishes

HONESTY

RELIABILITY

INTEGRITY

PERFECT FOR...



SIGNS & SYMBOLS

FIRE EXIT SIGNS

Fire exit signs are used on doors, emergency or fire escape routes. The Contract Range range of fire exit signs incorporates 75mm letter height to comply with Fire Precautions Act 1971 and include 'symbol only' versions to suit EC Council Directives.



LG.LA 60 054 - 140mm-470mm

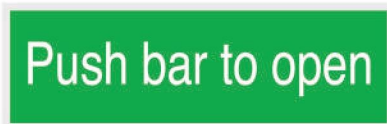

LG.LA 60 052.1 - 65mm X 280mm

LG.LA 60 052.2 - 130mm X 565mm

- ▶ Designed to comply with EC Council Directive 92/558/EEC and Fire Precautions Act 1971
- ▶ Supplied with wood screws or self adhesive pads for alternative fixing method
- ▶ All signs available in the following finish and fixing combinations:
 - Aluminium -screw fixed
 - Aluminium -self adhesive
 - Vinyl-self adhesive
 - Plastic - screw fixed
 - Plastic- self adhesive

Sizes

The standard signs are available in the sizes shown. All the signs are available in the other sizes to special order.

Please Note

The signs shown on this page are for identification purposes only. They are not shown to scale, please refer to the dimensions shown.

Photoluminescent Signs

The signs shown on this page are also available in photoluminescent material which are energised by exposure to light. When the light source fails, the material emits a highly visible luminescence which lasts for several hours. The natural photoluminescent daylight colour of light green has been officially recognised in BS 5499 and BS 5378 as suitable for use in safety signs.

SIGNS & SYMBOLS

A series of 75mm diameter plates with engraved symbols. Supplied with wood screws for surface fixing. For further options on signage please contact your Laidlaw Gulf Sales Consultant.



Hooks

Finishes

Item No.	Description	Finishes		Unit
		SS	PS	
LG.LA600.75.01.153	MALE SYMBOL	•	•	single
LG.LA601.75.01.153	FEMALE SYMBOL	•	•	single
LG.LA602.75.01.153	DISABLED SYMBOL	•	•	single
LG.LA603.75.01.153	UNISEX SYMBOL	•	•	single
LG.LA604.75.01.153	BABY CHANGE SYMBOL	•	•	single
LG.LA605.75.01.153	SHOWER SYMBOL	•	•	single
LG.LA620.75.01.153	PUSH SYMBOL	•	•	single
LG.LA621.75.01.153	FIRE DOOR KEEP LOCKED	•	•	single
LG.LA630.75.01.153	PULL SYMBOL	•	•	single
LG.LA631.75.01.153	FIRE DOOR KEEP SHUT	•	•	single
LG.LA632.75.01.153	AUTOMATIC FIRE DOOR KEEP CLEAR	•	•	single
LG.LA633.75.01.153	FIRE ESCAPE KEEP CLEAR	•	•	single

All dimensions are shown in mm

- ▶ Refer page No. 17 & 18 for Codes, Grades & Finishes

HONESTY

RELIABILITY

INTEGRITY

PERFECT FOR...

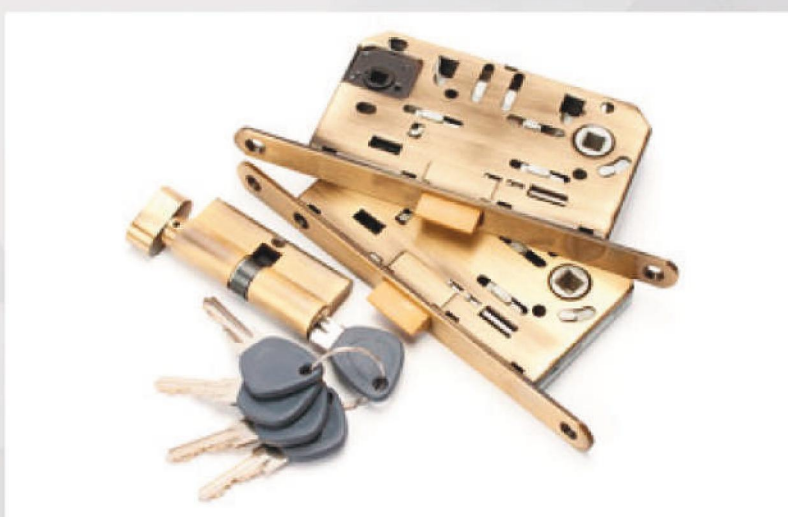

ACCESSORIES

FLUSH BOLT

Lever Action Flush Bolts for timber and metal doors

To order Radiused Corner Flush Bolts, please add the suffix R to the end of the product reference number

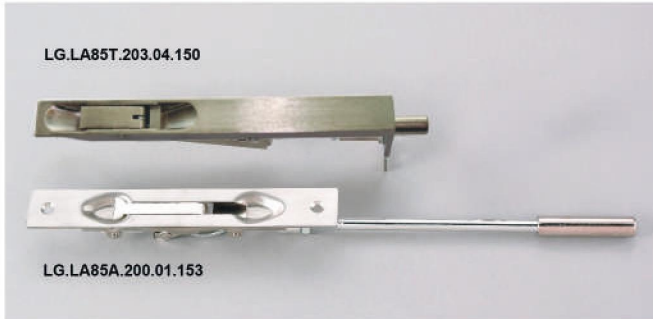

Flush Bolts

Item no.	Description	Finishes
LG.LA85T.203.04.150	203 x 19mm for timber doors	CP&SNP
LG.LA85T.203.04.150R	203 x 19mm for timber doors	CP &SNP
LG.LA85A.200.01.153	170 x 25mm for metal doors *	SS
LG.LA87.013.01.153	Dust excluding socket	SS

* Metal door bolt is supplied with a 200mm extension rod as standard (300mm to order)

* Other sizes are available to order.

Flush Bolts - Grade 316

Item no.	Description	Finishes	
		SS	PS
LG.LA.34 002.3.01.154	200 x 19mm for timber doors to EN12051	•	•
LG.LA.34 003.201.154	300 x 19mm for timber doors to EN 12051	•	
LG.LA.34 002.3.01.154R	200 x 19mm for timber doors to EN12051	•	•
LG.LA.34 003.201.154R	300 x 19mm for timber doors to EN12051	•	•

AUTOMATIC FLUSH BOLTS

UL Listed for 3 hour fire rating | Non handed | For wood or metal doors | Finish SSS as standard



Item no.	Description	Finishes
LG.LA85A-UW/610W	For wood doors	SS
LG.LA85A-US/610M	For steel doors	SS
LG.LA87 .019.01.153	Socket	SS

All dimensions are shown in mm

5 Year Guarantee

► Refer page No. 17 & 18 for Codes, Grades & Finishes

ACCESSORIES

DOOR STOPS

A range of floor skirting and wall mounted door stops



LG.LA401.32.01.153

Item no.	Description	Finishes
LG.LA400.00.01.153	Floor mounted	SS, CP & SC
G.LA401.32.01.153	Floor mounted (32mm0 Pillar type)	SS & PS
LG.LA402.76.01.153	Wall mounted (76mm)	SS & PS

HOOKS

A range of surface fixed hooks



LG.LA84.00.01.153

LG.LA86.00.01.153

LG.LA21.00.01.153

Hooks

Item no.	Description	Finishes		Unit
		SS	PS	
LG.LA86.00.01.153	Buffered hat/coat hook	•	•	single
LG.LA84.00.01.153	Hat/coat hook	•	•	single
LG.LA21.00.01.153	Coat hook	•	•	single

DOOR GUARDS

A series of door security guards and chains
 Surface mounted door guard | Concealed door chain
 Available in Satin Chrome, Satin Nickel or Polished Chrome
 Plated 2 year guarantee

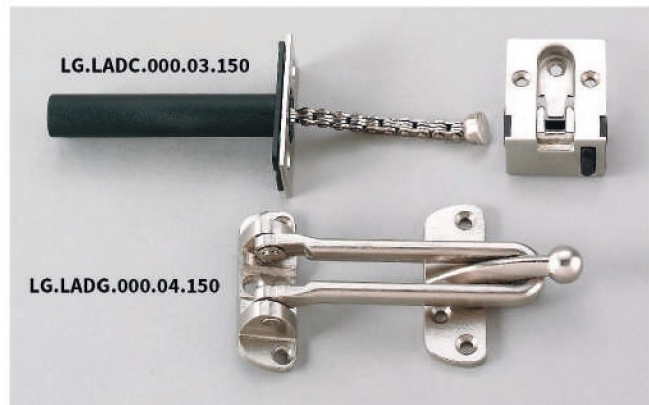

LG.LADC.000.03.150

LG.LADG.000.04.150

Door Guards

Item no.	Description	Finishes
LG.LADG.000.04.150	Surface mounted door guard	SCP, CP&SNP
LG.LADC.000.03.150	Concealed door chain	SCP/SNP
LG.LACC.000.04.150	Door chain, leather covered	SNP

All dimensions are shown in mm

5 Year Guarantee

► Refer page No. 17 & 18 for Codes, Grades & Finishes

ACCESSORIES

DOOR HOLDER I LIMITING STAY

A foot operated spring loaded doorholder.
Mortice Limiting Stay



Item no.	Description	Finishes
LG.LA404.00.04.150	Foot operated door holder	SCP/SNP
LG.LA35012	Limiting Stay	GALV

03 - SCP Finish
04 - SNP Finish

DOOR CO-ORDINATOR

Door co-ordinator for use with rebated double doors to close the doors in the correct sequence.



LA827



LA825



LA826

Item no.	Description	Finishes		Unit
		SS	PS	
LG.LA825.000.01.153	Door Co-ordinator (Spring loaded type)	•	•	single
LG.LA826.000.01.153	Door Co-ordinator (Gravity type)	•	•	single
LG.LA827.1067.01.153 HD	Door Co-ordinator	•	•	single



MK2 Door Co-ordinator

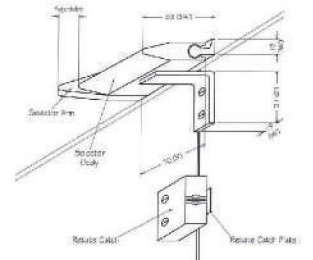

DOOR VIEWERS



Door Viewers

Item no.	Description
LG.LA406.55.04.150	180° viewer for doors up to 55mm thick No cover
LG.LA407.60.04.150	200° viewer for doors up to 60mm thick Glass lens & cover cap

All dimensions are shown in mm

5 Year Guarantee

► Refer page No. 17 & 18 for Codes, Grades & Finishes

HONESTY

RELIABILITY

INTEGRITY

PERFECT FOR...

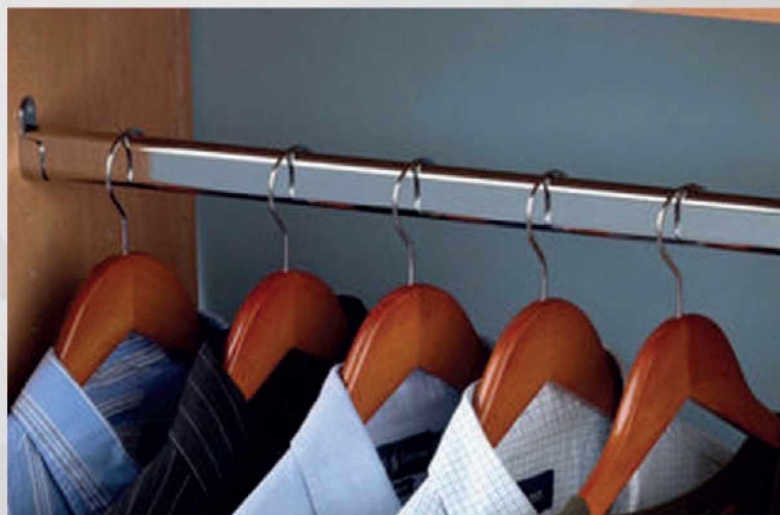

LS500H

BALL BEARING SLIDE 45mm Soft close Full extension

Soft Close Full extension ball bearing slide
 Side clearance $12.7^{+0.1}_{-0.2}$ mm (1/2")
 Loading capacity 45 kg (100lbs)

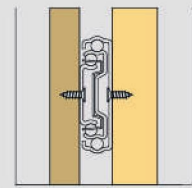

Suitable for wooden cabinets



- ▶ Application : General home furniture
- ▶ Feature : Full extension.
Lever disconnect for drawer removal.
Less noise at closing and opening.
- ▶ Loading capacity : 45 kg / 100 lbs
- ▶ Material : Cold rolled steel
- ▶ Finishes : Electro-zinc with bright yellow, blue or black oxidized
- ▶ Size : 300mm–700mm
- ▶ Side clearance : minimum 12.5mm;
Maximum 13.5mm.
The ultimate clearance 12.7mm–13.2mm.
- ▶ Soft closing time : 1.2–1.8s
- ▶ Opening force : 12–15N
- ▶ Soft closing distance : 40mm

OPTIONAL ACCESSORIES



Steel rear mounting bracket



Plastic rear socket

ASSEMBLY

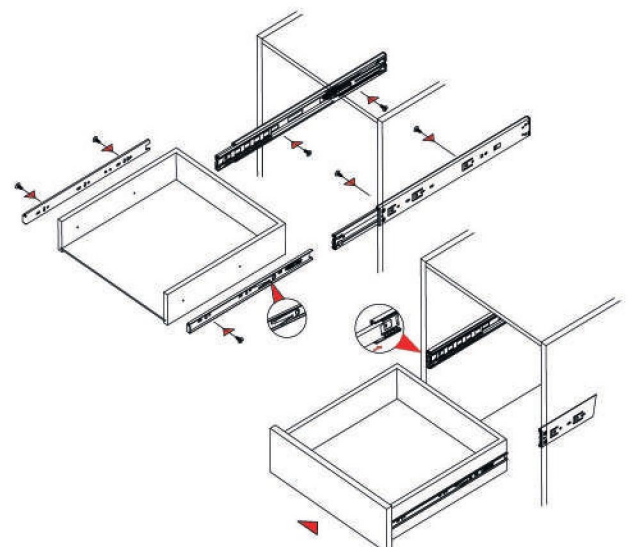
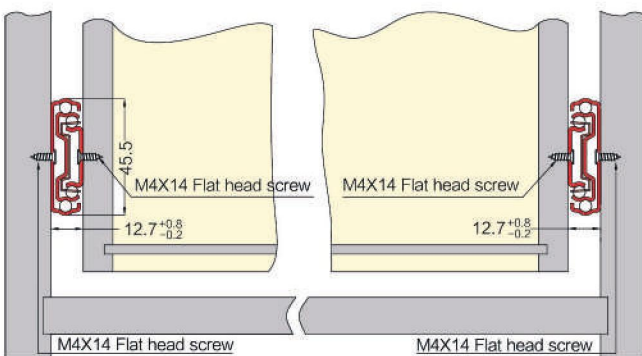

LS200H

SOFT CLOSING FULL EXTENSION / SINGLE EXTENSION UNDERMOUNT SLIDE



- ▶ Perfect light, smooth, silent self and soft close system
- ▶ Quick and easy assembling and dismantling
- ▶ Height adjustment 0 ~ +3mm
- ▶ Loading capacity 30 kg

RUNNERS LEFT/RIGHT



SPACE REQUIREMENT

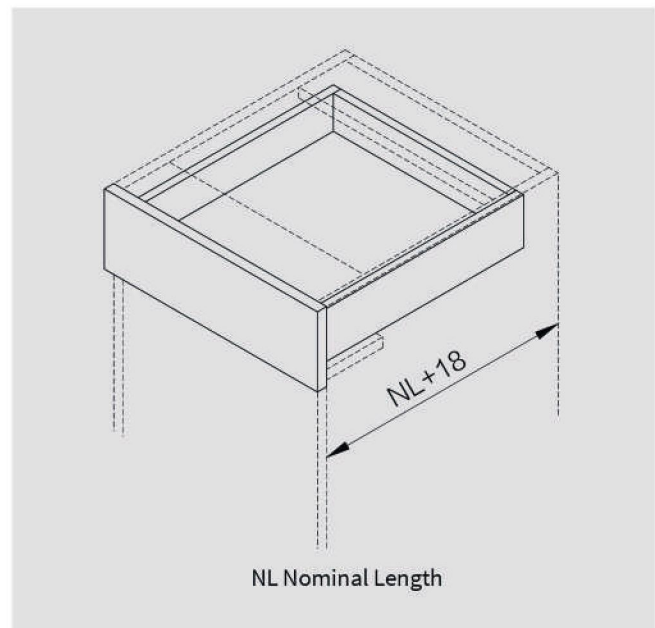

LOCKING BRACKETS LEFT/RIGHT



BASIC COMPONENTS

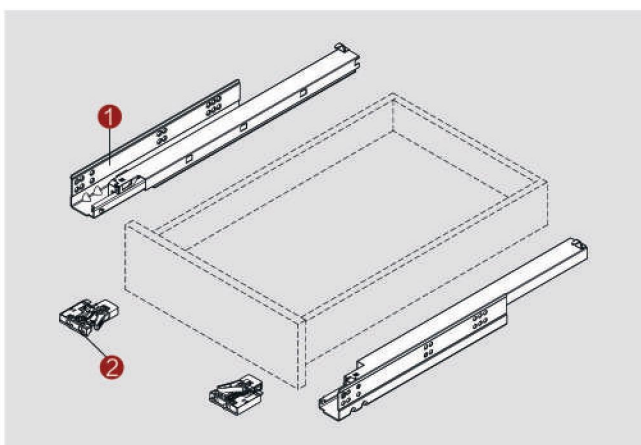

NOMINAL LENGTH NL

270mm

300mm

350mm

400mm

450mm

500mm

550mm

LS300H

SLENDER METAL DRAWER



- ▶ Extra slender side panel, maximizing internal drawer space
- ▶ Colour White, Grey
- ▶ Fully synchronised motion, smooth opening and closing
- ▶ Quick and easy assembling and dismantling
- ▶ Handy 3D front adjustment
- ▶ Dynamic loading 40 kg
- ▶ Optional tilting adjustment

KIT PACKAGE

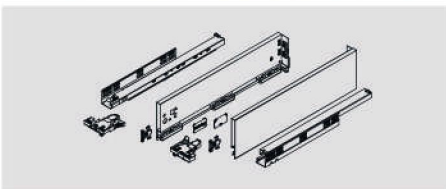

SIDES



DRAWER SIDES

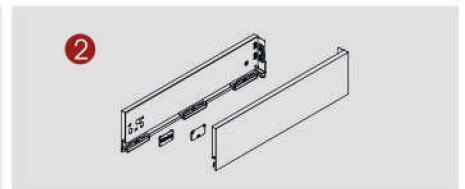

BOTTOM FIXING-BRACKETS

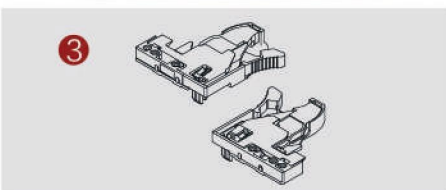

FRONT FIXING-BRACKETS

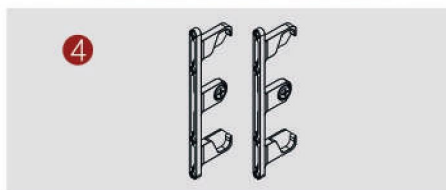

SCREWS



BASIC COMPONENTS

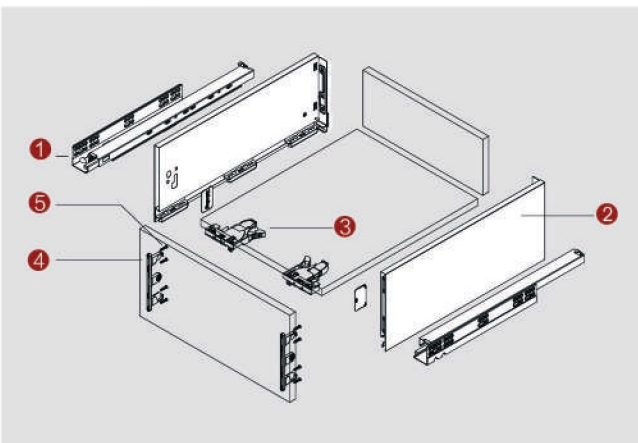

SPACE REQUIREMENT

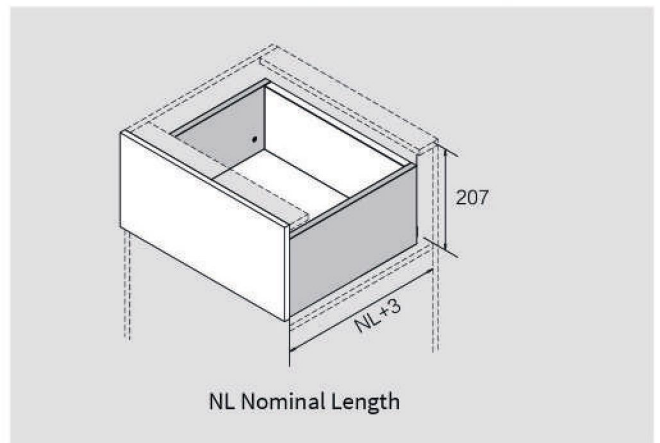

NOMINAL LENGTH NL

270mm 300mm 350mm 400mm 450mm 500mm 550mm

DRAWER HEIGHT (H)

89mm 121mm 185mm

LS400H

LUXURY DRAWER

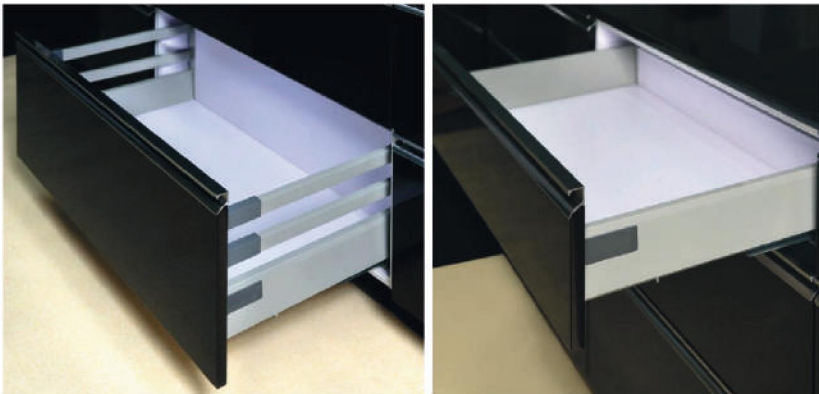

- ▶ Concealed, full extension, synchronised slides
- ▶ White, silver grey, stainless steel
- ▶ Light opening & closing, smooth sliding
- ▶ Quick installation and easy dismantling
- ▶ Integrated 3D front panel adjustment
- ▶ Dynamic loading capacity : 35 kg

KIT PACKAGE

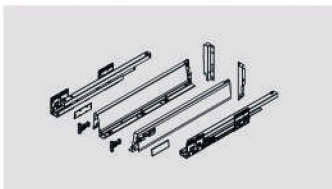

SIDES

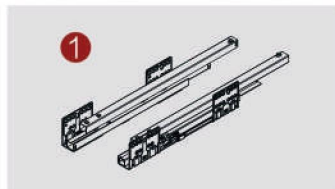

DRAWER SIDES

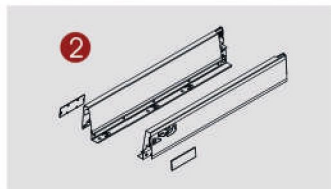

BACK FIXING-BRACKETS LEFT/RIGHT

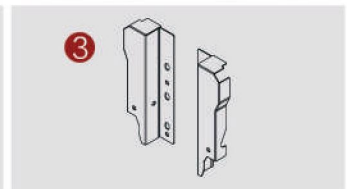

FRONT FIXING-BRACKETS

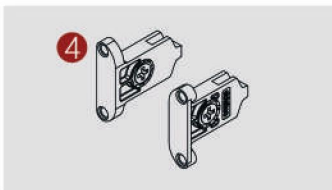

SCREWS



RAILS LEFT/RIGHT

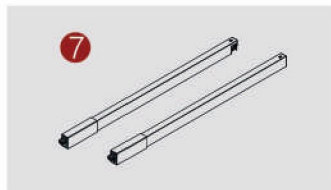

MID RAILS LEFT/RIGHT



BASIC COMPONENTS

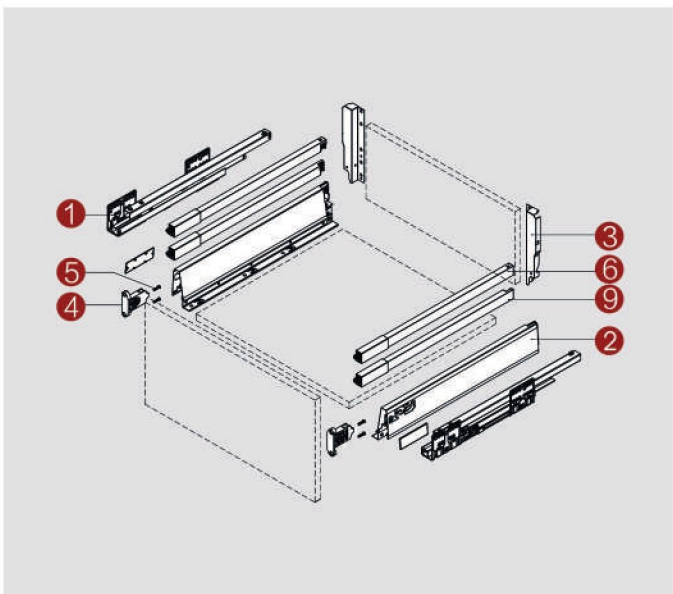

SPACE REQUIREMENT

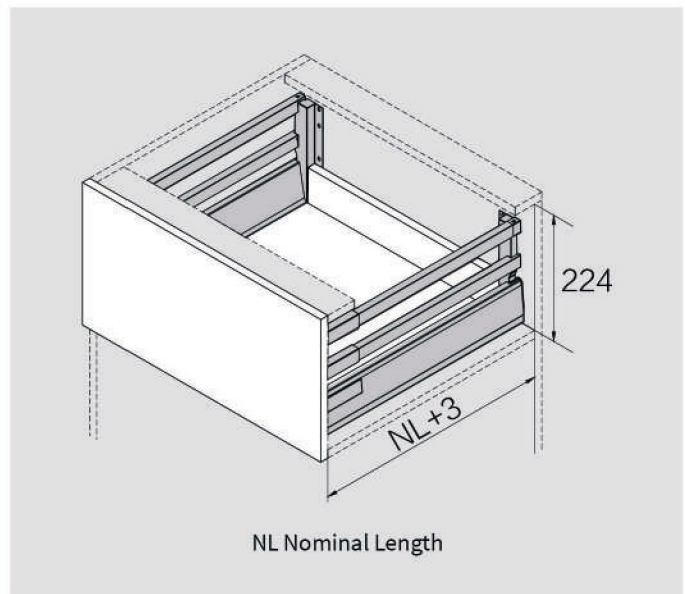

NOMINAL LENGTH NL

270mm

300mm

350mm

400mm

450mm

500mm

550mm

LH100A 35MM

SOFT-CLOSE HINGES---CLICK-ON



Product Description

- ▶ Open angle : 110°
- ▶ Diameter of hinge cup : 35 mm
- ▶ Cup depth : 11.5 mm
- ▶ Drilling distances on the door : 3~6mm
- ▶ Range of door thickness : 15~25mm
- ▶ Door Adjustment :

Height adjustment	+2mm-2mm
Side adjustment	+2mm-2mm
Depth adjustment	+3mm-2mm

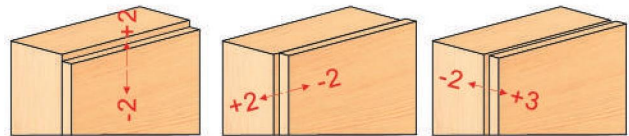

HINGE - CLICK ON WITHOUT SOFT CLOSING BLIND CORNER HINGE



Product Description

- ▶ Open angle : 110°
- ▶ Diameter of hinge cup : 35 mm
- ▶ Cup depth : 11.5 mm
- ▶ Drilling distances on the door : 3~6mm
- ▶ Range of door thickness : 15~25mm
- ▶ Door Adjustment :

Height adjustment	+2mm-2mm
Side adjustment	+2mm-2mm
Depth adjustment	+3mm-2mm

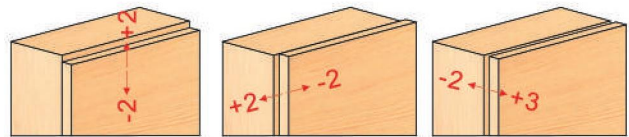

LH110S 35MM

SOFT-CLOSE HINGES---SLIDE-ON



Product Description

- ▶ Open angle : 110°
- ▶ Diameter of hinge cup : 35 mm
- ▶ Cup depth : 11.5 mm
- ▶ Drilling distances on the door : 3~7mm
- ▶ Range of door thickness : 15~25mm
- ▶ Door Adjustment :

Height adjustment	+2mm-2mm
Side adjustment	+2mm-2mm
Depth adjustment	+3mm-2mm

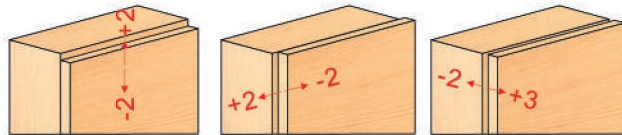

FULL OVERLAY



HALF OVERLAY



INSET



LH300S 165°

EUROPEAN SOFT CLOSE HINGE SERIES — CLICK-ON

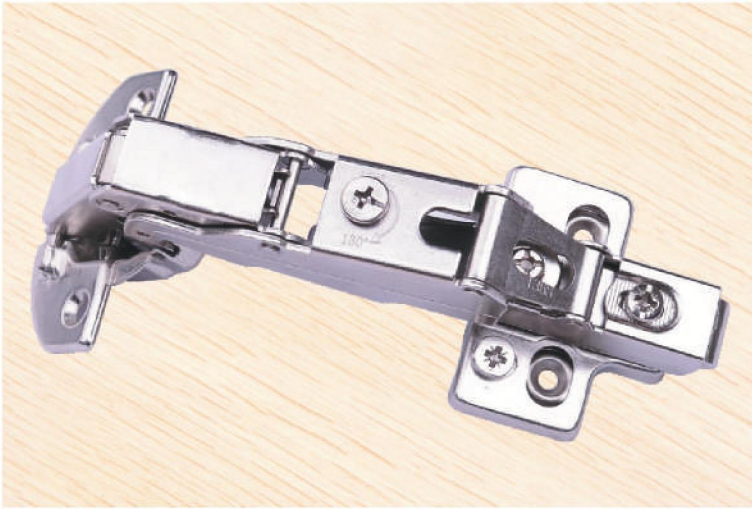

Product Description

- ▶ Open angle : 165°
- ▶ Diameter of hinge cup : 35 mm
- ▶ Cup depth : 12 mm
- ▶ Face panel measurement : 3~7mm
- ▶ Recommended door thickness : 16~26mm
- ▶ Opening angle adjustment : 130° ~ 165°
- ▶ Door Adjustment :

Height adjustment	+2mm-2mm
Side adjustment	+2mm-2mm
Depth adjustment	+3mm-2.5mm

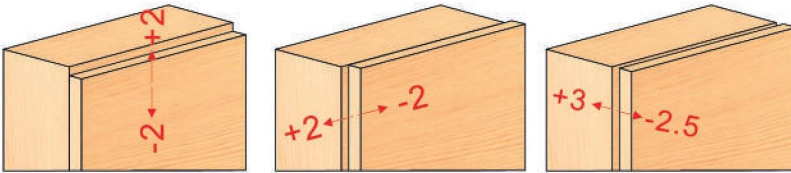

CLICK-ON WITH CAM

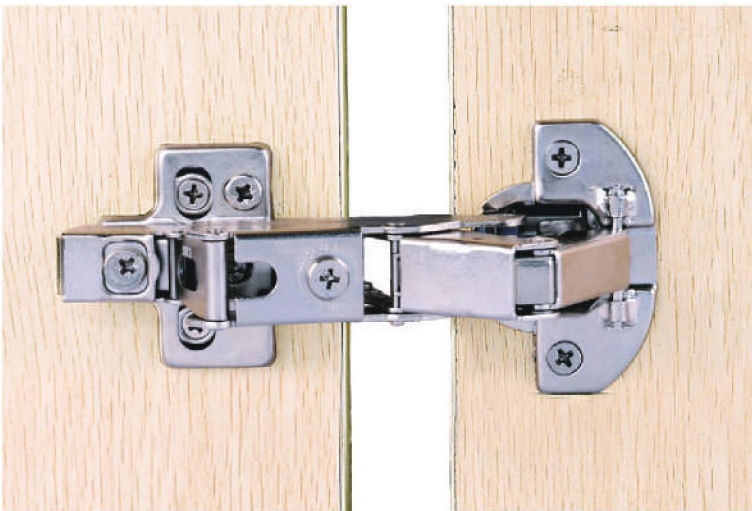

Product Description

- ▶ Open angle : 165°
- ▶ Diameter of hinge cup : 35 mm
- ▶ Cup depth : 12 mm
- ▶ Face panel measurement : 3~7mm
- ▶ Recommended door thickness : 16~26mm
- ▶ Opening angle adjustment : 130° ~ 165°
- ▶ Door Adjustment :

Height adjustment	+2mm-2mm
Side adjustment	+2mm-2mm
Depth adjustment	+2mm-2mm

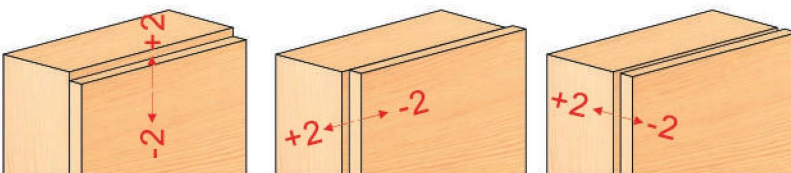

LH400S 35MM

+90° ANGLE SOFT CLOSE HINGE SERIES — CLICK-ON



Product Description

- ▶ Angled hinge : +90°
- ▶ Open angle : 100°
- ▶ Diameter of hinge cup : 35 mm
- ▶ Cup depth : 11.5 mm
- ▶ Drilling distances on the door : 3~6mm
- ▶ Range of glassdoor thickness : 15~25mm
- ▶ Door Adjustment :

Height adjustment	+2mm-2mm
Side adjustment	+3mm-2.5mm
Depth adjustment	+3mm-1mm

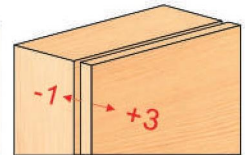
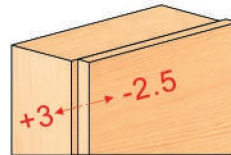
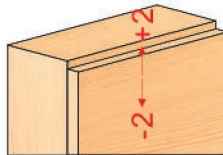

CLICK-ON WITH CAM



Product Description

- ▶ Angled hinge : +90°
- ▶ Open angle : 100°
- ▶ Diameter of hinge cup : 35 mm
- ▶ Cup depth : 11.5 mm
- ▶ Drilling distances on the door : 3~6mm
- ▶ Range of glassdoor thickness : 15~25mm
- ▶ Door Adjustment :

Height adjustment	+2mm-2mm
Side adjustment	+2mm-2mm
Depth adjustment	+3mm-1mm

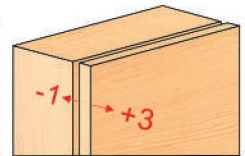
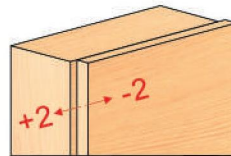
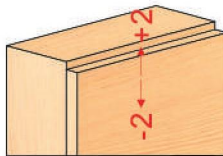

CONCEALED HINGES



HINGE COVER

ARM DECORATIVE COVERS



CUP DECORATIVE COVERS

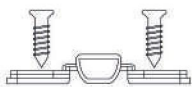

Wood Screw

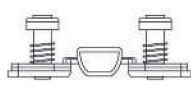

Euro Screw

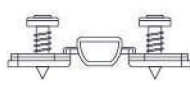

Preloaded
Wood Screw



Expand Dowel

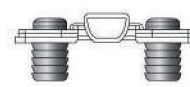

Pressure Dowel



Expand Dowel

ACCESSORIES

CABINET FITTINGS



CABINET HANGER WITH SUPPORT PLATE

KNOCK DOWN (KD) FITTING



LOCKS AND CATCHES

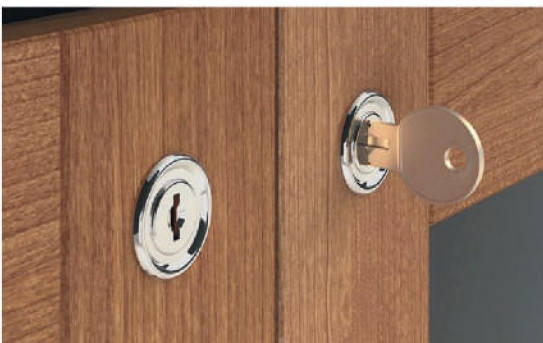

ACCESSORIES

FURNITURE LEGS



PROFILE HANDLES

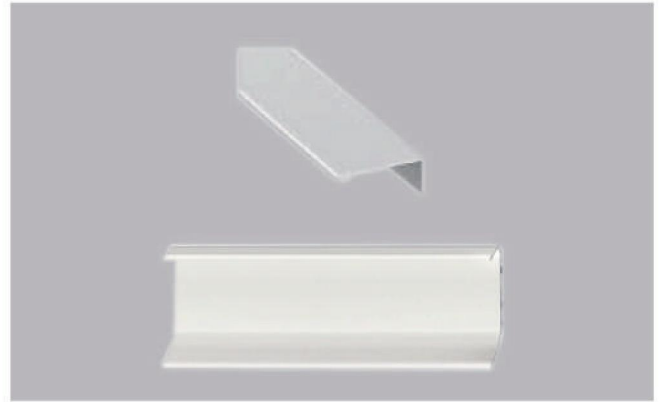

PULLOUTS

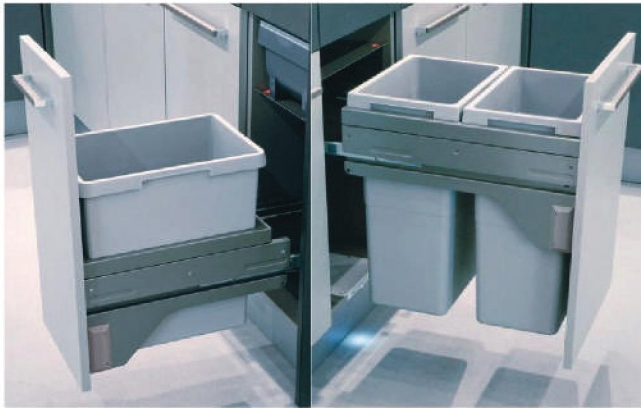

WARDROBE RAILS & CAPS

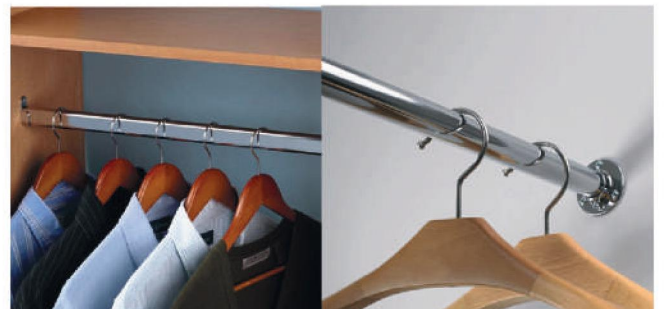

HONESTY

RELIABILITY

INTEGRITY

LIPPING

100% Solvent Resistant

PVC and ABS

Wood Grain 2000 Working Shades

Lead and BOPP Free

Acrylic 2 Colour Tone Edging

3D Acrylic



www.laidlaw.ae

LIPPING

Dual Color Acrylic Edge Banding



Aluminium Surface Edge Band



Soft Buffer Profile



Printed Edge Band



Welcome to the latest product offering from **Laidlaw Gulf LLC**. As a value added service to our many joinery customers, we can now assist in the manufacture and supply of lipping for your projects.

Laidlaw Gulf LLC can now be the preferred supplier for all of your lipping needs. We can supply lead free PVC/ABS and edge banding/profiles among many other examples. Edge banding widths range from 17 mm to 70 mm and thickness ranges from 1 mm to 3 mm. We are also producing ABS/PVC jumbo wide sheets with thickness starting from 0.45 mm PVC and 0.6 mm to 1.5 mm ABS, 700 mm width. We can match any colour requirements that your customers may have.

Our product range includes rigid modified PVC and ABS. Our standard edge band products are 1 mm to 3 mm edges in various widths. We have more than 2000 working shades both in solid/uni and printed wood grain. We are also producing edging in 3D acrylic and 2 tone acrylic.

Should you have any requirements, please let us know.

Email us today info@laidlaw.ae

LIPPING

PRODUCT TECHNICAL DATA SPECIFICATION

1. General

Thaicil PVC Edge bandings are Thermo plastic edging developed for decorative finishing of panels. They have a protective as well as a design function. The edge bandings are produced from PVC (Poly Vinyl Chloride) E5-10-003, which is Lead free as well BOPP free and completely imbued.

2. Limits

Thickness	Width
+/- 10%	+/- 10%

3. Level Parallelism

All Available Widths	≤ 0.10 mm
----------------------	-----------

4. Pre Tension

Widths < 70 mm	0.00 - 0.35 mm
Widths >= 100 mm	> 0.1 mm

5. Longitudinal Deformation

All Available Widths And Length	< 3.0 mm to 1 mm
---------------------------------	------------------

6. Longitudinal Deformation

All Available Widths And Length	< 3.0 mm to 1 mm
---------------------------------	------------------

7. Packaging Details

Length Of Coil	100 lm
Box Size	10 cm x 60 cm x 60 cm
No Of Coils Per Box	4 Coils/Box

8. Properties

Properties	Measuring Methods	Units	Test Values
Sp. Gravity	UNI4294/ASTM D792	GR/CC	1.34 ± 0.03
Vicat Softening	ASTM 1525	Deg. cent.	94 ± 3
Impact Strength	ASTM D 256	Kg.-cm./cm	Min 70
Hardness Shore – D	ASTM D 2240		74-76
Shrinkage at 80° C for 1 hour	Company		< 1.0 %
Solvent Resistance	Din 53472		100 % Resistant after 24 hours
Water Absorption	Company		Less than 0.1 %

9. Cleaning

For Cleaning Thaicil PVC Edge band, we recommends special plastic cleaning agents. Test first reliability on a small sample. Never use Alcohol based or MEK solvent based cleaning agent.

10. Storage Conditions

Store under proper conditions-on a dry and cool place (< 30°C), protected from direct sunlight and dust. Edge banding are applicable for a minimum period of 1 year time.

LIPPING

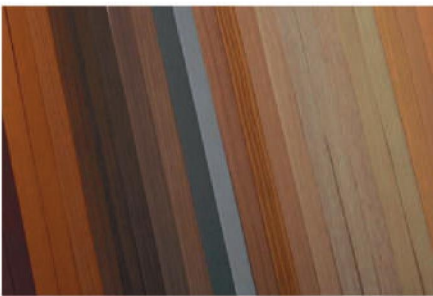

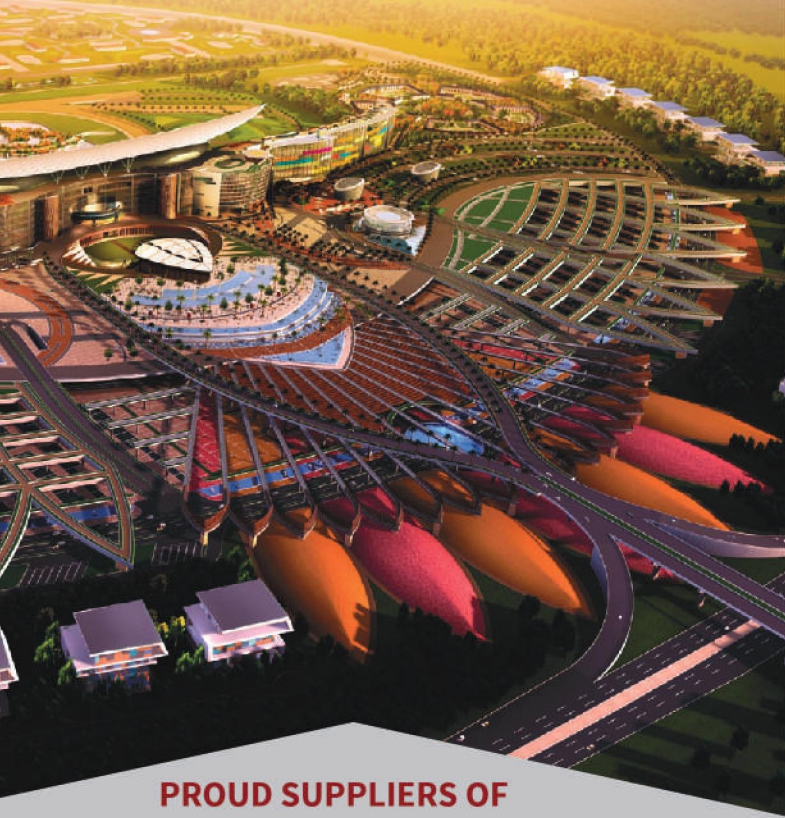

PROUD SUPPLIERS OF



LGAI for FM

We understand the challenges you face, which is why we have created this service specifically for the FM industry. We have worked on projects in many industries that rely on FM; hospitals, schools, office buildings, hotels. We know exactly what sort of hardware you require and endeavor to keep it in stock at our warehouse in Dubai.

Cut through long shipping delays when you need door hardware immediately. Contact us for your private secure log in details, and view a live inventory to see if we have what you need in our warehouse. Same day collections serve, or next day delivery. If we don't have the product in stock, let us know what you need, and how soon you need it, and we will be sure to get it for you ASAP!



LGAI for Procurement

Trust. Reliability. Integrity. Experience the Laidlaw Gulf way. Send us your RFQ today, and see how we can provide a variety of services for you. We can match specs but improve service and quality on EVERY project. Or if budgets are tight we can VE our products but not our service levels. They will always be the very highest in the industry. We have a complete range of certified and NFR products designed for any budget. Our scheduling service means that we can double check the numbers to ensure no mistakes are made. Our post installation service means that we don't finish a project until you finish a project. Allow us to de-stress your project for you.





PROUD SUPPLIERS OF



LGAI for Architects LGAI for ID

The construction boom in the MENA region continues unabated. All sorts of buildings are being built at a rapid pace; hotels, housing developments, leisure facilities, office blocks. Architects have never been busier. Let Laidlaw Gulf make your job that much easier by handling any hardware scheduling you may have been given as part of the project. Our GAI trained team can come to your offices and chat to your PM department about the requirements on a project by project basis. Our extensive knowledge of the region means that we can supply both door and hardware schedules to meet any time frame. Email us today to arrange a meeting with our experts. Let us make your life easier by doing what we are best at!

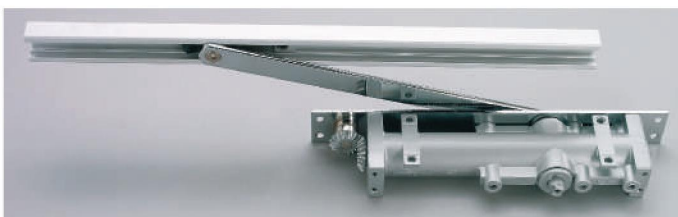

The single thing missing from any design concept submitted to a client is usually the ability to physically feel exactly what the designer intends in their artwork. Previously, long lead times and expensive prototypes have restricted ID companies to 2 dimensions. 3D printing has changed all that. Clients will now be able to judge your designs in a tactile sense as well as visually. Contact us for your private secure log in details, upload digital designs or sketches of your ideas, and we will 3D print them in either a demo or fully working model in just a few days.

We have been working around the ID industry for many years and know that 3D printing will be a game changer. Don't get left behind!



Laidlaw Gulf LLC is wholly owned by our UK parent company International Interior Solutions Ltd, t/a Doorsets International and has been trading since 2007. Laidlaw Gulf LLC has agents throughout the MENA region and is currently expanding into Asia and Africa.



LIDLAW GROUP LIMITED (UK)

Unit 16, Eastway business village olivers place,
Foolwood, Preston, Lancashire, United Kingdom PR2 9WT
E: info@laidlaw-group.co.uk



LIDLAW GULF LLC

301, Mayfair Building, DIP-1, Dubai, UAE
Tel: +971 4 8857404 | E: info@laidlaw.ae



Our Accreditations

Our Brands



Certified ISO 9001 - 2015 company

